

How To Ride A Motorcycle Off Road

Riding Techniques for Large Dual-Purpose Bikes

By David Petersen (aka Mr. BestRest)



Reading this Article won't make you an expert Off Road rider, but it might teach you a few things. It might give you a few pointers, and it might help you improve whatever Off Road skills you now have. This Article covers the Basics. It's not a substitute for expert instructors who can take you to the field and give you 1-on-1, hands-on instruction.

Why Did I Write This Article? (Some now call it a "book")

I wrote it because I want to raise YOUR understanding of what it takes to ride Off Road. I want to educate you and empower you so that you'll be able ride to the places I ride, and do things that I enjoy doing. My purpose is not to sell you BestRest gear <http://www.bestrestproducts.com>. (By way of full disclosure you should know that I own the company). Yes, I make or sell gear that's mentioned in these pages but I'll try to avoid turning this Article into a sales pitch. If you choose to buy some of my Company's gear that's great, but that's not my motivation for writing.

Every day I talk to customers who call my shop to place an order. During our conversations they ask my opinion about gear they'll need for Off Road riding. They also ask me to describe riding techniques, help them with trip preparation, and more. I share what I can, time permitting. I concluded I could do a better job if I put my ideas down on paper so that others could benefit from my riding expertise (or lack thereof). My own expensive and painful lessons learned over the years can be your classroom.

What makes me qualified to write this Article? Some might say I'm clearly NOT qualified, since I hold no racing titles or other prestigious awards that publicly proclaim my competency. Point taken, I'm not offended. Others might say I'm possibly qualified because I've ridden a variety of bikes for fifty-plus years, and because I've ridden a few noteworthy adventure routes. Others might say the mere fact that I've survived that many years aboard 2 wheels makes me eminently qualified. Read the entire Article then you decide whether I'm qualified. During the process you might learn a few things you didn't know, or you'll be reminded of things once learned, but forgotten.

A special thanks to my long time riding buddy Steve Irby. We've ridden together for several years and we've taken some pretty memorable trips on our BMW's. Steve provided some of the photos in this Article.

Table Of Contents

The number to the left of the Topic Line refers to the approximate line of text within this Article. Line numbers are helpful when referring back to a particular topic and for finding your place on the page. RED underlines indicate significant changes or additions to that section since the last version of the Article.

1. Introduction and Overview

- 31. Why Ride Off Road?
- 62. Feedback from Readers
- 77. Sharing This Article w/Others
- 86. Article Updates
- 93. Disclaimer
- 117. Other Off Road Riding Resources
- 139. Reading A Manual VS Field Exercises
- 175. Will You Get Hurt Riding Off Road?
- 188. Will You Damage Your Bike?
- 219. Rider Competency Matrix
- 261. My Off Road Riding Credentials
- 342. Selecting a Motorcycle
- 353. Rules of Thumb for Off Road Riding
- 397. Common Myth-Conceptions About OR Riding

- 419. Bike Setup
- 577. Selecting Tires and Wheels
- 657. Tire Pressure
- 724. Riding Gear
- 808. Physical Conditioning
- 835. Equipment to Carry On the Bike
- 948. Camping Gear**
- 1104. Emergency Gear
- 1160. Loading Gear On the Bike
- 1216. Gear You Should Carry On Your Person
- 1249. Tools To Carry On the Bike
- 1361. Tire Repair Tools
- 1449. Repairs On The Trail
- 1553. Tire Repairs
- 1580. Tire Changes

1621. Off Road Riding Techniques

- 1649. Standing On The Pegs
- 1649. Five Off Road Riding Positions
- 1751. Foot Position & Shift Lever / Brake Pedal
- 1793. Turning the Bike
- 1844. Throttle Control
- 1859. Gripping the Bars – Both Hands
- 1890. Gripping the Bars – Right Hand
- 1924. Gripping the Bars – Left Hand
- 1948. Braking – Front Brake
- 1992. Braking – Rear Brake
- 2042. Braking – Bike and Body Position
- 2091. Using the Clutch
- 2124. Shifting Gears
- 2148. What To Do When You Fall Down
- 2276. Climbing a Hill
- 2352. Getting Stuck on A Hill
- 2424. Going Down A Hill Steep Hill
- 2533. Look Where You Want the Bike To Go

- 2560. Anti-Lock Braking Systems
- 2588. Off-Camber Surfaces
- 2627. Terrain Identification
- 2685. Crossing Water Obstacles
- 2748. Riding on Gravel
- 2805. Riding In Sand
- 2947. Riding In Snow
- 2991. Riding In Mud
- 3012. Riding a Forest Road
- 3051. Riding a Single Track Trail
- 3076. Riding In Ruts
- 3183. Jumps and Whoops
- 3237. Crossing Logs and Other Obstacles
- 3271. Turning Around On a Narrow Road or Trail
- 3411. Riding With Other Motorcycles
- 3458. Towing a Disabled Bike / Recovery**
- 3631. Jump Starting a Bike
- 3680. Bump Starting a Bike
- 3719. Exceptions to These Techniques

3745. Field Exercises You Can Practice

- 3758. Five Riding Positions
- 3790. Front and Rear Wheel Placement
- 3808. Braking – Rear Brake Only
- 3843. Skid Steering
- 3874. Braking – Front and Rear
- 3903. Clutch and Front Brake
- 3926. Starting Out On A Hill

- 3947. Turning Around On A Hill
- 4021. Figure 8's and Slalom
- 4121. Static Balance Drills
- 4187. Off Camber
- 4228. Sand and Mud
- 4265. Swing-A-Leg Drill
- 4303. Conclusion

Addendums: Check the last page of this Article for recent updates. When I have time I blend them into the article. Until that happens, any recent changes are posted on the last lines of the Article.

1 **Introduction and Overview**

2
3 What's "Off-Road" riding? For this Article it means riding away from the pavement, on surfaces that include gravel
4 roads, unimproved dirt roads, wide trails, and the occasional cross-field excursion. This Article is NOT about hard-
5 core off roading, not about single-track alpine trails, not about enduro riding, or not about motocross riding. You
6 might see photos of some small displacement trail bikes, but that's only because a photographer was along for a
7 ride that particular day.

8
9 This Article is written for the average guy or gal who rides a big-bore dual-purpose motorcycle like a BMW F800GS,
10 R1150GS, R1200GS, Suzuki V-Strom, Wee-Strom, Kawasaki KLR, KTM 950/990 etc. etc. etc. These are the
11 types of bikes I normally ride. Big ones. I must be compensating for something – short legs.

12
13 In the Article I'll refer to the reader/rider as a Guy, but this also applies to any Gal who reads these pages.

14
15 Reading this Article will NOT make you an expert off road rider, but it might give you some tips that improve
16 whatever off road skills you possess. If you don't already have off road skills, it might inspire you to get some
17 professional training that will get you started in the world of adventure riding.

18
19 In this Article I'll be using the abbreviations "OR" or "OR'ing". Either term means Off Road Riding.

20
21 As with most learning disciplines, there's some classroom time you've got to serve before you get to part where I
22 describe field exercises. That's where I'll talk about the actual skills and techniques of OR'ing. Be patient and
23 wade thru these pages. You'll want to have a full understanding of the foundations. Don't try to run before you
24 learn how to walk.

25
26 My apologies if I go into too much detail about a specific riding technique... I'm trying to communicate complicated
27 processes to readers who may not understand. Absorb what you can, skip over the rest. Come back later and see
28 if those words have "sunk in" and make sense at a later time.

29
30
31 **Why Ride Off Road ???**

32
33 Why would you want to ride OR? Ninety percent of the world's roads are unpaved. If you limit your travels to the
34 pavement, you're missing out on a lot of fun. There's a new world of adventure and 2-wheeled excitement that
35 begins as soon as the pavement ends. You can be part of it. All you need are some helpful tips, some educational
36 materials, a few accessories, perhaps some training classes, and soon you'll be ready to ride your bike OR.

37
38 One reason people don't ride OR is that they're afraid they might damage their bike, or injure themselves, or get
39 into a situation they can't handle. My goal is to cut those Boogie Men down to size and help the average rider step
40 out of his comfort zone. The rewards are substantial. Its not possible to fully describe them on paper.

41
42 Riding Off-Road is FUN. You see places most people never see. You visit places most people have never even
43 heard of. You'll have riding experiences and create memories that stay with you for a lifetime.

44
45 Want to learn more about riding OR, in some of the most beautiful country found on the planet? Want a good
46 resource page for OR routes? Check this site:

47 <http://www.backcountrydiscoveryroutes.com/blog/>

48
49 For the best professional OR training I recommend
50 Rawhyde Adventures. [http://www.rawhyde-](http://www.rawhyde-offroad.com/)
51 [offroad.com/](http://www.rawhyde-offroad.com/). They run the official BMW Off Road
52 Training School. There's no better place to learn how
53 to ride OR. They don't pay me to recommend their
54 school – I do it because I believe that Jim Hyde and
55 his Staff run the best show out there. They can take a



56 rider who's clueless when it comes to OR'ing, and turn him/her into a reasonably competent adventure rider in less
57 than a week. They give you the basic tools, then you need to go out and use them.

58
59 RawHyde also has a road show that travels to various BMW dealerships around the US, putting on mini-seminars.
60 Check the RawHyde website to get the details.

61
62

63 **Feedback from Readers**

64

65 Since this Article is intended to educate, it's important that the materials be accurate. If you find an error in the text
66 please bring it to my attention and I'll make corrections when time permits. Email me: info@bestrestproducts.com or
67 <http://www.bestrestproducts.com/t-contact.aspx>. When you write please refer to the date at the lower left of the
68 page, the line number, and the specific topic or underlined header. I'll make corrections as needed. What I've
69 written is my own opinion, based on personal experience or the experiences of experts in the field. That doesn't
70 mean I'm right or that my methods are written in stone. Differing opinions or techniques don't necessarily mean the
71 information is faulty or inaccurate; instead it may be that there's more than one way of doing things. I'll change my
72 Article if you can convince me there's a better method, a superior technique, or a different way to solve a problem. I
73 don't claim to have a monopoly on the brain market, even though some of my friends call me "Mr. Know-It-All". And
74 I certainly don't lay claim to having all the answers when it comes to Off Road Riding, all I'm doing here is compiling
75 techniques I've learned along the trail.

76
77

78 **Sharing This Article With Others**

79

80 I intend for you to share this Article with others. None of the techniques I describe are "owned" by anyone, myself
81 included. All of the information found on this page is available in the public domain, however, for legal reasons the
82 text in this Article is copyrighted. Please don't copy it word-for-word and post it elsewhere, unless you first get my
83 written permission. When you do share it with others, please credit the source and list web page address (BestRest
84 Products). Contact me if you have questions about this policy.

85
86

87 **Article Updates**

88

89 This is a work in progress, constantly changing, constantly getting updated, almost like a blog. You'll see the date
90 and time of the Article in the lower left corner of the page. Make sure you're reading the latest version. You can
91 download the updated Article from the BestRest website.

92
93

94 **Disclaimer**

95

96 It seems silly to have to write this paragraph, but there are a few really dumb people out there who need a written
97 warning for everything. They need a poster telling them that hot coffee can cause burns, or that they can get a
98 nasty paper cut from opening an envelope, or that jumping your motorcycle across a canyon or fording a raging
99 river may result in a damaged motorcycle, or broken bones, or worse. Duh. You'd think those hazards would be
100 apparent and people would take precautions, but some don't. For that reason I'll warn you ahead of time that the
101 information shown on this page is not all-inclusive, it was not written by an Expert, it may contain errors, and it
102 contains information that may not be applicable to your situation. If you ride a motorcycle you assume a level of
103 risk, and if you ride a motorcycle Off Road you'll assume additional risks. Do us a both huge favor - don't bother
104 reading this page or try to follow the techniques I described in these pages if you're not willing to assume full and
105 complete responsibility for your own actions. Speaking bluntly – put on your Man Pants. Don't blame me if you do
106 something stupid on your motorcycle. Don't sue me if you try a technique described on these pages, but in the
107 process you fall down and get an oowie or a boo-boo. These methods and techniques worked for me, but they
108 may not work for you. I've tried to describe them as best I can, but many things get lost in the translation.

109

110 Neither the Author nor BestRest Products, LLC assumes any responsibility whatsoever for personal injury or
111 damage to personal property as a result of the information described or techniques shown on these page.
112

113 Use some common sense. If you're running short on what seems to be a rare commodity, we offer the BestRest
114 Common Sense Kit for a nominal fee. Unfortunately the Kit doesn't work for everybody and it doesn't come with a
115 money back guarantee. <http://www.bestrestproducts.com/p-342-common-sense-kit.aspx>
116
117

118 Other Off Road Riding Resources

119 Looking for other sources of material about Off Road Riding? Here's a few:
120
121

- 122 1. **Adventure Lifestyle Website (ADVLife.us)** – a new web forum devoted to expanding the ranks
123 of big bore off road riding. Sponsored by BMW North America, RawHyde Adventures, BestRest Products,
124 and other selected Companies, this page acts as an informational hub for adventure riders. You'll find info
125 on trusted vendors, info on upcoming rides, and you'll find the best source for riding instruction.
126

127 <http://www.ADVLife.us/>
128



- 129 2. ADVRider forum. A large web forum dedicated to all aspects of motorcycling. You'll need some patience to
130 sort thru all the threads. As with most online forums, there's going to be a few contributors who might
131 challenge your patience. Ignore them. <http://www.advrider.com/>
132
133 3. Google the words "how to ride off road" and you'll get hundreds of hits. A 2-second Google search will give
134 you hundreds of resources. Sort thru them carefully, separating the wheat from the chaff. Harvest the
135 good bits from each site, then go to the next field and pick some more fruit.
136
137
138
139

140 Reading A Manual VS Field Exercises

141 There's only so much you can learn from reading about OR riding, just as there's only so much you can learn about
142 flying an airplane from reading a Cessna flight manual. Yes, you can learn a lot from these pages, but there's no
143 substitute for actually putting your butt on the saddle and riding out of the garage. Take the techniques I've tried to
144 describe for you and go out in the real world and carefully practice those techniques. Practice by yourself and
145 practice with your friends. Discuss the techniques with your riding buddies. Think about the techniques while
146 you're riding. Envision them. Let them be absorbed. Only then will you be able to call upon them when you really
147 need them.
148

149 In order to become proficient at OR'ing, you'll need to test your limits. You don't want to test them in the midst of an
150 unexpected obstacle along the trail. Instead you want to test your limits in a controlled setting, according to your
151 own terms. The best place to test them is under the
152 tutelage of training professionals. They'll put you in
153 real-world scenarios, they'll do it in a safe fashion,
154 and they'll give you lots of positive reinforcement.
155
156

157 I enthusiastically recommend RawHyde Adventures
158 in California – they're the Masters when it comes to
159 training. They also put on seminars and rallies at
160 BMW and other motorcycle dealerships across the
161 US. <http://www.rawhyde-offroad.com/>
162



163
164
165
166

If you're in the Seattle/Tacoma area you can attend courses by Puget Sound Safety. They offer a wide variety of Off-Road courses, tailored to your skill level. They provide professional training for all riders. <http://pssor.com/>



167
168
169
170
171
172

If you're in northern Oregon you can get training from RideCoach. Ramey "Coach" Stroud taught me quite a few techniques that I describe in this Article. <http://www.ridecoach.com/>



173
174
175

Will You Get Hurt Riding OR?

176
177
178
179
180
181
182
183

Maybe... If you ride OR, you're going to fall down, it's inevitable. It may be a 2 mph tip-over, or it might be a 10 mph washout. Properly attired, you should escape injury. When you're properly trained you can avoid most of the situations that would result in a fall or possible injury. Motorcycling is an inherently a risky sport but the risks are acceptable when you consider the rewards. Personally I've never broken any bones, but I've had some sprains and scrapes and cuts along the trail. I've also bruised my ego, which probably hurt as much as any fracture.

184
185
186

Riding OR carries about the same risks as downhill skiing. A few skiers will break their leg and a few OR'ers will break their leg. Consider the risks and consider the benefits. Personally, I'm willing to take reasonable and prudent risks because the rewards are substantial. Are you?

187
188

Will You Damage Your Bike Riding OR?

189
190
191
192
193
194
195
196
197
198
199
200

Maybe... Guards, shields, and other hard parts will minimize the consequences of most tip-overs. If you ride OR long enough you can expect to replace the occasional turn signal, rear view mirror, or other dangly-bit. A few scratches on your saddlebags testifies your willingness to tackle the OR world. Some consider those scratches as a badge of courage, or a rite of passage. If you don't want to risk any damage, leave the bike in the garage and take the bus. A clean, unblemished bike testifies that there's a rider who plays it safe, who doesn't go into the boonies and challenge the terrain. At least that's the way I see it.

201
202
203
204
205
206
207
208
209
210
211

Just because you venture OR it **doesn't** necessarily mean your bike will end up looking like the bike in the photo at right. Some riders fear this kind of scenario so much that their bike never leaves the pavement. With proper education and practical skills training the chances of this kind of damage are pretty small, about the same chance as getting hit in the noggin by a meteorite or abducted by aliens. However if both of those things have happened to you in the last six months, maybe you should stay home. You're having a string of bad of luck.



212
213

That upside-down bike belongs to a friend of mine from Australia, Steve Smith of Adventure Moto. Upside down must be a southern hemisphere thing that us northerners can't understand. (FYI When Steve visits I don't lend him

214 one of my own bikes, especially after seeing this photo). If you're Downunder you can buy a wide range of
215 motorcycle adventure gear from Steve's online store: <http://www.adventuremoto.com.au/>
216



217
218
219

Rider Competency Matrix

220

221 If you're going to ride Off Road you'll need to examine or disclose a few things about yourself. What are your
222 strengths and weaknesses? What's your OR background? How willing are you to take some reasonable risks? Are
223 you ready to step out of your Comfort Zone?
224

225

226 Your level of knowledge and competency starts at ZERO and progresses as you learn more about OR'ing. This is
227 true whether we're speaking about cognitive learning abilities, or physio-motor skills. You'll need both.
228

229

230 Where do YOU fit in the following competency matrix? Be honest, nobody's gonna make fun of you. (Well, actually
231 they will make fun of you, but only if you try to ride into the next level of competency before you're really ready.)
232

233

Level 1 – Unconsciously Incompetent

234

235 This is the rider who doesn't have a clue - he doesn't know what he's doing and doesn't even know that he
236 doesn't know. His OR motor skills are totally dormant. Unfortunately this Level is too heavily populated. My
237 goal is to thin the ranks of Level 1 and move them up to Level 2.

238

Level 2 – Consciously Incompetent

239

240 This is the rider who realizes that he doesn't know what he's doing, so he obtains an elementary education
241 in OR techniques. He recognizes that he's incompetent, but at least that he won't put himself or others in
242 danger. He realizes that he'll eventually need someone to educate him and/or train him so that he can ride
243 his bike in a safe fashion. His motor skills have been awakened from their stupor, but they're still pretty
244 groggy. Most of those reading this Article will fall into this category. I hope this Article will inspire you to
245 achieve Level 3.

246

Level 3 – Consciously Competent

247

248 This is the rider who takes the tips and techniques he's read on these pages, and takes the time and
249 spends the money to practice those techniques. He spends money to get professional training in OR
250 techniques. After receiving training the rider knows what to do in a given situation, and he consciously
251 thinks about it as he performs a specific riding task. His motor skills are partially developed, but he needs
252 practice before he can play with the symphony in Carnegie Hall.

253

Level 4 – Unconsciously Competent

254

255 This is the rider who has read these pages, who went to a training program, who practiced what he learned,
256 and doesn't give a second thought to his riding technique... it's automatic and it's correct for the specific
257 situation. No conscious effort is required on his part. He "flows" as he rides and the bike becomes
258 part of him. This guy is the violin soloist. He makes it look easy.

259

Hopefully you'll move upward in the matrix after you've read this Article and taken time to practice these techniques.

260
261
262
263
264
265
266
267

My Off Road Riding Credentials:

Here's what I look like (sorry to disappoint you, I know you were hoping for more), and here's two of the four bikes I currently ride. Photo at left was taken at the conclusion of the Continental Divide Route. Photo at right taken on the Oregon Backcountry Discovery Route. The camera lens makes me look much wider and shorter than I really am, or than I'd like to be.



268
269
270
271
272
273
274
275
276
277
278
279
280
281
282
283
284
285
286
287
288
289
290
291
292
293
294
295
296
297
298
299
300

I started riding motorcycles at the age of about five. I don't remember the exact age, but I do remember falling down a lot. Maybe that explains a few things.... a hard blow to the head in my formative years.

My Uncle had a H-D / Triumph dealership in southern California. He also had one of the first Honda shops in the US. I grew up around motorcycles and in my teens I spent many days exploring the woods of Montana on my Honda trail bike.

As a lad of 15 years I rode my motorcycle to a driver's training class so I could get my driver's license. I'd already been riding around the streets of my hometown for a few years before that. I hid the bike around the corner from the classroom. Like a kid with his pony, we were inseparable. Life revolved around that green Honda SL100... I think I even slept beside the bike a few times. We kept each other warm.

As a police officer I rode a Kawasaki 1000cc police bikes for several years. I would often ride it on the dirt trails around my patrol area. That could be where my love of big off-road bikes started. I'd take that Kaw 1000 on dirt trails and on hills when nothing else was happening. And in doing so, I fell over a couple times.

I've ridden most of western US on pavement. I manage to putter along pretty effectively. Some might say I do it too slowly, but what do they know? I ride my own pace, and you should too.

I've ridden to the Arctic Circle, Prudhoe Bay (Dead Horse), Alaska on a R12GS. That was a long but interesting journey that gave me plenty of opportunities to practice OR skills on dirt, mud, and loose gravel.

I've ridden the Continental Divide Route (S-N) on a R12GS. That was a great trip – definitely one for the Bucket List. You'll encounter every imaginable road condition and you'll see some amazing country.

I've also ridden the Continental Divide Route (N-S) on a F8GS. Due to mud in lower elevations and snow in the passes I wasn't able to complete that journey. I had the wisdom to throw in the towel - there's always next year.

I also ride a KTM 450 EXC and Suzuki DR200; both are great platforms for practicing OR drills. Once I have the drills down pat, then I go out on the big BMW's and practice them again.

301 I've ridden most of the Washington Back Country Discovery Route before it was officially defined, and did most
302 of that 2-up with Long Suffering Wife sitting patiently on the back. She's a good sport and doesn't mind
303 pushing/pulling when required. She keeps me from doing anything stupid, at least most of the time.
304

305 I've ridden forest roads where I've met Forest Rangers who were truly amazed that I was able to ride there on my
306 big bore BMW. I've also surprised a few hard-core dirt bike riders who couldn't imagine riding the BMW up those
307 trails. Their praise of my riding skills made the journey worthwhile. They didn't witness the occasional tumbles
308 along the trail.
309

310 I've explored most of Washington state's unpaved roads on my BMW, and many of the forest trails in western
311 Washington on my KTM and Suzuki trail bikes. I'll keep exploring as long as I'm able.
312

313 I prefer to ride OR instead of pavement, which means I TRY to spend most of my time in the dirt. Because we live
314 in an imperfect world I can't spend all my time riding OR on my dual sport bikes. Pavement exists. Deal with it.
315

316 I've attended a few OR riding schools over the years, which further refined my self-taught skills, and helped me
317 unlearn a few bad habits I'd developed. Every school I attend I learn something new.
318

319 I'm not an expert and don't claim to be one; I'm just an average guy who happens to know a bit more than the
320 average rider when it comes to riding OR. My experience and knowledge might be useful to others.
321

322 I'm not a big guy who can physically manhandle a 1200cc motorcycle thru difficult OR situations. Instead I'm short,
323 I'm fat, and some say I'm ugly. Nevertheless I've learned to tame the big bore motorcycles by using subtle
324 techniques, as opposed to brute force. Like a flea on a dog's back, I get the bike to do what I want it to do.
325

326 I learned to ride SLOW before I learned to ride FAST. Well, I suppose FAST is a relative term. To me it's fast, but
327 to others it's apparently pretty slow. In any case, my technique always results in a successful day of OR riding,
328 with minimal mishaps and LOTS of fun.
329

330 I have an adventurer's spirit that compels me to go places that others might consider too difficult to travel aboard a
331 large displacement dual-sport a motorcycle. Nothing ventured, nothing gained.
332

333 I do have some common sense (in spite of what others might say), so I don't intentionally perform foolhardy stunts,
334 put my bike or myself in jeopardy. I know my limitations. I know my comfort zone, but I don't mind pushing my
335 riding limits, within reason.
336

337 I told you all this so you'd understand that you don't have to be Superman to ride OR. I'm not. Think of me as a
338 cross between Don Knotts and Super Dave Osborne, with a bit of John Candy thrown in. Some have likened me to
339 "George Kostanza" from the TV program "Seinfeld". Personally, I don't see any resemblance.
340
341

342 **Selecting a Motorcycle**

343
344 What kind of bike should you select for Off Roding? Several brands and models come to mind. If you're in the
345 market, you can't go wrong with a BMW F800GS, R1200GS, the Triumph 800, the new Yamaha Tenere, the KTM
346 640/950/990, Kawasaki KLR, etc. Selecting a bike is largely a matter of personal preference. I like the BMW brand,
347 but others like the KTM, so to each his own. The techniques and principles are the same.
348

349 By the time most readers view this page they already have their bike, so selecting another bike is not an option.
350 You'll have to ride what you currently own. You can always plan for the future, dreaming about the next one.
351
352

353 **A few rules of thumb about OR'ing:**

354

- 355
356
357
358
359
360
361
362
363
364
365
366
367
368
369
370
371
372
373
374
375
376
377
378
379
380
381
382
383
384
385
386
387
388
389
390
391
392
393
394
395
396
1. The smaller the bike the better, especially when learning new techniques. Learn small, grow big.
 2. The less gear you have, the better. Practice OR without all your gear to help you learn the basic techniques. But before you head to the hills you need to demonstrate that you can still perform those techniques after the bike is fully loaded. An extra 100 pounds of gear makes the bike handle differently.
 3. When heading out on a journey, don't take the kitchen sink. Avoid carrying too much gear, keep weight to a minimum. I seem to have trouble remembering this rule. After the Continental Divide Ride I weighed ALL my gear – it topped the scales at 186+ pounds (including the weight of the saddlebags). I evaluated each item I carried and determined that 70 pounds of it wasn't needed. If you're carrying more than 100 pounds of gear (including the weight of the panniers), you've probably got too much stuff. I challenge you to get an accurate scale and weigh each item you're carrying on the bike. Write it down. You'll probably be surprised at how much stuff you're packing around. A few ounces here, a few ounces there, and pretty soon you've added 50 pounds of gear.
 4. The more you practice your OR technique, the better you become. Reading about it doesn't cut it. Doing it once won't teach you much – you have to practice. Practice, practice, practice.
 5. The more you read, the more you'll learn, and the better rider you'll become. Educate yourself, read articles, watch videos. Don't rely on one source for your OR education (that means you shouldn't rely on this Article as your only source of information).
 6. Know your limitations. If you're at Level 2 of the Competency Matrix, don't attempt some ride beyond your ability. On the other hand, don't play it safe all the time. At some point you'll need to test your limits. Be willing to spread your wings, be willing to leave the comfort of your nest. Do it gradually, taking small steps.
 7. Smooth is fast. Don't try to ride fast. Instead, ride "Smooth". Smooth means using proper techniques, at a comfortable pace. Eventually your smooth pace will result in faster speeds.
 8. Don't let others set your riding pace. It's common to see a group of riders take off at a brisk pace, with one rider being dragged along at speeds (and conditions) beyond his skill level. Eventually he crashes. Don't let that unfortunate rider be YOU. Ignore your buddy's comment that you're riding like an "old man". Remind them that you ARE an old man, or that you plan to be around long enough to become one.
 9. Ride only as fast as you're willing to crash. A friend once cautioned me about my riding speeds on my KTM 450. He commented that I was going pretty fast, and asked me if I was willing to crash at that speed. My reply was a firm "NO". I was pushing my skill limits so I dialed things down a few notches. Silly me.
 10. Check the testosterone at the door. Don't get into a macho match or a pissing contest when it comes to riding OR. You'll lose. It hurts and it costs lots of money to repair the bike (or repair yourself).

Common Myth-Conceptions About Riding OR

- 397
398
399
400
401
402
403
404
405
406
407
408
409
410
1. You don't have to be 6'4" to ride OR. I tend to think of myself as standing 6'8"... ok, to be perfectly honest I'm probably around 5'7" in stocking feet. Being short doesn't keep me off a big BMW R12GS.
 2. You don't have to be a weight lifter to ride OR. I'm short and fat and need to work out more. I can't lift the bike with one arm. I don't need to - I'm smarter than that. I use proper technique instead of brute force.
 3. You don't have to be able to put both feet flat-footed to ride OR. I can barely touch my toes on the ground. I'm used to that. Once you're underway it doesn't matter anymore.
 4. You don't have to spend a lot of money on gear. However, when you do purchase equipment or riding gear, spend your money wisely, spend it once, don't buy the cheapest item, and always invest in quality.

- 411 5. You don't have to ride as fast as the other guys. Ride at your own pace. They'll wait for you. If they don't,
 412 then it's time to find new riding companions.
 413
 414 6. The fastest rider isn't necessarily the best rider. Speed isn't the determining factor in rider skill. Smooth
 415 technique and an enjoyment of the complete riding experience are the hallmarks of the best Off Road
 416 Riders. Leave fast riding for the track, or for the young men who still think they're invincible. They aren't.
 417
 418

419 **Bike setup**

420 Following is a list of suggested modifications to your motorcycle. Although not required, these modifications reduce
 421 the chances of damage to your bike, PLUS they'll make your OR'ing experience more enjoyable. BestRest makes
 422 gear for BMW motorcycles that does a good job of protecting those vital areas.
 423

- 424
 425 1. Skid plate or other engine protection against stumps, rocks, and other
 426 obstacles. Don't leave your bike's soft underbelly unprotected, or it'll
 427 look like this. Photo at right shows how a large rock peeled open the
 428 oil sump, leaving the rider
 429 stranded.



430
 431 A smooth bottom on a skid
 432 plate lets the bike slide over
 433 logs or rocks. If the
 434 mounting bolts aren't flush
 435 with the surface then the
 436 bike can hang up. Holes on
 437 the sides let dirt and mud
 438 escape and improve air flow
 439



- 440
 441 2. Crash bars and engine protection. When the bike goes down,
 442 you'll want something to protect the engine and the sides of the
 443 gas tank. Crash bars fit the bill. There's a lot of vendors out there
 444 who will be happy to sell you a set of crash bars. Shop wisely,
 445 taking into account the cost and the ease of removal when it
 446 comes time to perform routine repairs. For the BMW R12GS I've
 447 been satisfied with the bars made by BMW, but other brands do equally well or perhaps even better. For
 448 the BMW F8GS rider BestRest offers Metal Mule crash bars. I've got them on my F8GS, and they've
 449 proven themselves in a number of ... um... shall we say "horizontal episodes".
 450 <http://www.bestrestproducts.com/p-172-crash-bars.aspx>
 451



- 452
 453 3. For the BMW R12GS those cylinders heads stick out pretty
 454 far, ready to snag a rock or stump or other obstacle. When
 455 you go down they'll be plowing a furrow in the ground, so in
 456 addition to crash bars you'll also want aluminum cylinder head
 457 protectors. You can get them from a variety of sources.
 458
 459 4. Oil cooler guard, or radiator guard to protect those fragile
 460 components against rocks or sticks. You can find these
 461 products for the BWM F8GS and R12GS on the BestRest
 462 website. [http://www.bestrestproducts.com/c-97-bmw-](http://www.bestrestproducts.com/c-97-bmw-gear.aspx)
 463 [gear.aspx](http://www.bestrestproducts.com/c-97-bmw-gear.aspx)
 464
 465
 466





467
468
469
470
471
472
473
474
475
476
477
478
479
480
481
482
483
484
485
486
487
488
489
490
491
492
493
494
495
496
497
498
499
500
501
502
503
504
505
506
507

5. Tires – see the specific section on tire selection. Whatever brand you select, they need to have an aggressive “knobby” tread. Street tires don’t cut it. Tires that are designed to spend 90% of their time on the pavement riding don’t cut it either. You’ll want a tread design that’s got large knobs for best traction.
6. Mirrors – you can get folding mirror stalks that allow you to move your mirrors inward when not needed. This is helpful when riding in sand or other technical conditions where the chances of a tip-over are fairly high. Folding mirrors also keep errant branches from grabbing ahold of your bike, wrenching the bars away. If you don’t want to invest in folding mirrors, then loosen the nut that locks the mirrors onto the handlebars. Make the tension just tight enough to keep the mirror from moving under normal circumstances, but still allows the mirror to rotate when it hits something hard, like a tree branch or the ground.
7. Foot pegs - serrated for good grip in wet or mud. BMW footpegs come with a rubber insert which is slippery when wet. Pull off those inserts and put them on the shelf. When it comes to footpegs, wider is better. I prefer Pivot Pegz because they rotate slightly as you move on the bike, and because they’re wide enough to support your arches when standing. <http://www.pivotpegz.com/>
8. Brake pedal extension – it’s often necessary to get a larger brake pedal or some type of bolt-on extension that makes it easier to find the pedal when you’re standing on the pegs. There’s a lot of manufacturers that make them. Get the kind that’s serrated so it grips your boot when covered with muck.
9. Handlebars – they must be adjusted for proper rider position, which means they have to be adjusted so the rider is comfortable while standing on the pegs – more on this later.
10. Saddlebags - soft or hard depending on your preference. For really tough technical riding, soft bags might be better because they weigh less, they don’t carry as much gear (keeping the weight down), and they act like cushions when you fall. The downside is that when you do fall down they may rip or tear. Hard bags made from aluminum cost more, hold more, and weigh more. But they’re more secure, lockable, and in the event of a tumble they protect the bike and the rider’s legs. I like Metal Mule aluminum panniers but there are lots of other choices out there. <http://www.bestrestproducts.com/c-101-metal-mule-products.aspx>
11. Headlight protection - a grill or screen to protect against rocks. A small pebble thru the headlight can cost you \$500. If you ride OR your headlight’s going to take a beating. BestRest makes models to fit the BMW R12GS and F8GS. Photo on right shows what a big rock will do when it hits the plastic screen – its better to replace a \$30 piece of plastic than a \$500 headlight. I’ve saved the headlights on my both my BMW bikes because of these protectors. That means I’ve got an extra \$1,000 to spend on tires, or camping gear.



508
509
510
511
512
513
514
515
516
517
518
519
520
521
522
523
524
525
526
527
528
529
530
531
532
533
534
535
536
537
538
539
540
541
542
543
544
545

12. Hand guards - to protect your hands against rocks, brush. In event of a tumble they protect the levers. Most OEM hand guards are more cosmetic than they are functional. Aftermarket guards made by Acerbis and other companies offer more protection than the hand guards supplied by the motorcycle manufacturer. That being said, I've had no complaints with my BMW OEM hand guards. They've done the job of protecting me and the bike. I've fallen on them several times and been able to bend them back into shape.
13. Handlebar adjustments. Most bikes come with the handlebars rotated backwards to make them comfortable when seated. That's great for the Dealer when he's making a sale in the showroom, but that position isn't suitable for OR'ing because much of the time you'll want to be standing on the pegs. Loosen the bar clamps and rotate the bars forward until the bars are comfortable when standing. Retighten the clamps. It's important that you carry that handlebar clamp wrench in your onboard toolkit so you can make adjustments on the trail.
14. After adjusting the handlebars, adjust the clutch and brake lever so you can easily operate them when standing. You shouldn't have to bend your wrist in order to operate either lever.
15. Some riders prefer to use "bar risers" so the handlebars are raised up an inch or more. This allows the rider to stand on the pegs more comfortably because they're not hunched forward over the bars. Even though I'm technically classified as "short", I still have 1" bar risers on all my bikes. They make standing much more comfortable.
16. You really don't need to outfit your bike with auxiliary lights or a lot of other cool accessories like you see in the magazines. They look trick but many of them really don't add much to the OR experience. I have auxiliary lights on my BMW GS's, but quite truthfully they do nothing toward my OR program. I seldom ride the highways at night anymore, and I never ride OR at night. But they do look cool, and sometimes the right image is every bit as important as practical functionality.
17. If you do add more gear make sure it protects the key components, or somehow upgrades known weaknesses on your brand of motorcycle. We all have a tendency to "farkle-up" a bike, thinking that by adding a piece of gear we're somehow making the bike better for the task at hand. While that may be true, be careful not to spend money on bits and pieces that look pretty, but don't really add much practical value. Ask yourself if you really need that anodized frammis shroud, or if you're just buying it on impulse. Don't farkle-up your bike just so it looks like the one you saw on the cover of a magazine. Don't buy everything you see in an aftermarket catalogue. And don't buy BestRest gear just because I have it on my bike or because I recommend or sell it. Buy gear that fits YOUR needs and fits YOUR budget.

546
547
548
549
550
551
552
553
554
555
556

18. Spare shift lever – these can get bent or broken. Strap a spare to the frame.
19. Spare brake or clutch levers. If they're easily replaceable, carry a spare. In your bike has a complex cast metal brake lever housing and/or hydraulic fluid reservoir then perhaps you can't carry a spare.
20. Brake pedal / shift lever – Run a section of dog collar chain or a thin steel cable between the frame and end of the brake pedal, and one between the frame and the shift lever. This chain or cable prevents a stick from jamming between frame and pedal, and snapping it off or bending it. If you ride in sagebrush or areas where grass or sticks are abundant these cables are really useful. You can now buy these protective cables from BestRest <http://www.bestrestproducts.com/c-19-accessories.aspx>

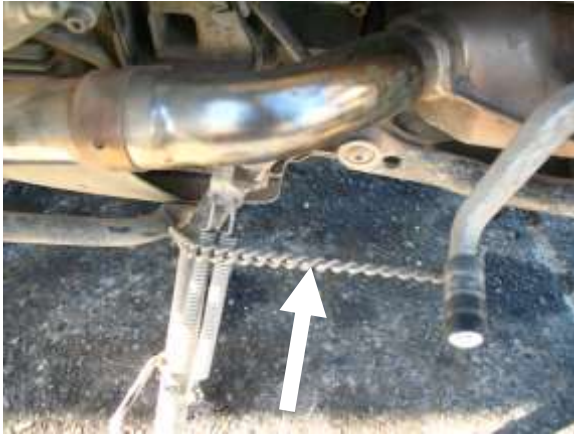

557
558
559
560
561
562
563
564
565
566
567
568
569
570
571
572
573
574
575
576

21. GPS. I consider a GPS to be standard riding equipment. Sure, I also carry paper maps, but I rely on the GPS for routing and for keeping track of where I've traveled. When I get home I download the tracks and save them for future viewing and ride planning. I like reviewing the tracks using Google Earth. When planning a big adventure like the Continental Divide Route, a GPS is worth its weight in gold. It holds tracks and routes, and allows you to concentrate on riding, instead of navigating.
22. Suspension upgrades. Most OEM stock suspensions are pretty lame. That means they're OK for street riding, but they fall short when it comes to OR'ing. Most OR'ers invest in aftermarket shocks which come at a high price, but the results are worth every penny. Suggested manufacturers include Progressive, Ohlins, Wilburs, HyperPro, and others. Consult suspension experts for tips on spring rates, preload, valving and other setup advice.
23. If you go with an aftermarket suspension, make sure you deal with a company that will set the suspension according to your riding style, your weight, and the gear you carry when riding OR. They'll put in a stiffer spring and make other modifications to give you the best ride in the dirt. Tell them your bike, your weight, your riding style, and they'll create a suspension system that really works.

577
578
579
580
581
582
583
584
585
586
587
588

Selecting Tires – Spokes VS Cast Rims – Tubed VS Tubeless

Recommending tires is like recommending motor oil. Everyone has a different opinion. Here's MY opinion:

I've ridden at least 100,000 miles aboard Metzler Tourances. They handle well, but their dirt abilities are very limited. They'll clog up in mud and once that happens they're pretty much worthless. If I'm headed for the hills I change from Tourance to something else that has a more aggressive tread pattern. Expect 8-10,000 miles on a set of Tourance tires before they need replacement.

Continental TKC-80 tires are pretty tough to beat when it comes to riding in the dirt, which is why they've become the gold standard tire for OR'ing. Their aggressive tread grips well in sand, mud, gravel, and loose soil. They're reasonably capable on pavement unless the roads are wet, in which case they're unsettling. Expect to replace the

589 rear tire after 4-6,000 miles, slightly longer for the fronts. This is my preferred tire on the GS for really tough off-
590 roading.

591
592 **Heidenau** makes a good dual-purpose tire that's not quite as aggressive as the TKC-80, but delivers twice the
593 mileage. The K60 Scout fits most big bore bikes. <http://www.heidenautires.com/dual-sport-tires/k60scout>
594 Here you see a pair about to go on my R12GS.



595 You can buy tires online and save lots of money VS buying them at the dealer. Here's a few sources:

596 Southwest Moto Tires <http://www.swmototires.com>

597 Emoto Tires <http://www.swmotorubber.com>

598 Two Brothers Tires <http://www.twobrotherstires.com>

600
601 Learn to change your own tires. You'll save a lot of money when you do it yourself. All you need to do the entire
602 job is a TireIron BeadBrakr, which is small enough to take with you when you ride in the field. You don't need to
603 spend a lot of dough on a tire-changing machine. Yeah, they're nice to use in the garage, but you can accomplish
604 the same task in about the same time with a BeadBrakr. <http://www.bestrestproducts.com/c-98-beadbrakr.aspx>
605

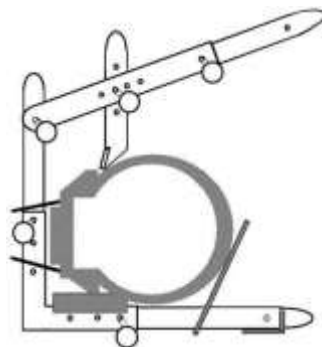

606
607 Photo above right shows a couple riders making a tire change and emergency repair by the side of the trail. All they
608 used was their TireIron BeadBrakr.
609

610
611
612
613
614
615
616
617
618
619
620
621
622
623
624
625
626
627
628
629
630
631
632
633
634
635
636

Rim Type – Spoked or Cast? Since you probably already have your motorcycle, you'll have to live with the types of rims that the manufacturer supplied, so rim selection is pretty much a moot point. That being said, I believe that spoked rims are far superior to cast rims when it comes to OR'ing. Spokes flex better and absorb hard hits that'll crumple cast or alloy rims. If you have a choice, get spoked rims. Leave cast wheels where they belong – on the pavement.

Tire Type - Tubed or Tubeless? If you have to make a choice between tubed or tubeless tires, I'd go with tubeless for a large displacement dual purpose bike.

Tubeless puncture repair is a piece of cake. I favor tubeless tires IF the bike is a BMW because they've got a unique tubeless tire/spoked rim system. If the bike is another brand, you'll need to choose the lesser of 2 evils – cast rims or tubed tires. In that scenario I'd go for tubed tires and spoked wheels.

Tubeless tires REQUIRE a perfect airtight seal between the rim and the rubber tire. If that seal is broken, the tire goes flat. When you hit a sharp rock it can deform the tire sidewall enough that the airtight seal fails. The tire deflates. You'll need to set the bead (re-establish the airtight seal) before you can seat the bead (re-inflate the tire). Note that "setting the bead" and "seating the bead" are actually two separate, distinct operations. Trying to re-seat a tubeless tire in the field can be problematic. BestRest has solutions for those tasks:

The DonorHose <http://www.bestrestproducts.com/p-45-donor-hose.aspx>

The BeadSetR <http://www.bestrestproducts.com/c-154-beadsetr.aspx>

Donor Hose – transfers air



BeadSetR – sets the tubeless tire bead



637
638
639
640
641
642
643
644
645
646
647
648
649
650
651

Tubed tires can be run at lower pressures than tubeless tires. That's because the tubes are holding the air, and they don't rely on contact between the rubber tire and the rim to keep that air in place. You do have to be careful when riding with tubed tires in rocky conditions, to prevent a situation known as a "pinch flat". That happens when the tire hits a sharp object so hard that the tube is actually cut by the rim. When that happens you'll be pulling the wheel off the bike and repairing or replacing the tube.

Tubeless tires can be repaired on the rim. Easy peasy. Tubed tires take a lot more work because they require removal of the entire wheel assembly from the bike, and removal of the tire from the rim. That's a real pain, especially when you're on some lonely jeep trail. But if your bike has tubed tires then that's what you'll have to do in the event of a puncture. Be prepared when it does happen, which means you'll need to carry all the tools to do the job. If you don't carry ALL the tools needed for an in-the-field tube repair or replacement, you might as well not carry any tire tools.

652 My BMW R12GS has tubeless tires which means I don't NEED inner tubes. But when I was riding to Alaska or on
653 the Continental Divide I still carried them. In case of a bad tubeless tire cut, I could stuff the tube inside the tubeless
654 tire, and limp to the nearest town where I could get a new tire.
655
656

657 Tire Pressure 658



Adjusting tire pressure for maximum traction is perhaps the easiest (and most important) thing you can do when it comes to OR riding. When a motorcycle tire rolls across dirt, gravel, or mud the tire needs to conform to the ground to get maximum traction. If the tire is over-inflated, it won't grip properly. The bike will feel like you're riding on

668 marbles and you'll feel like you're about to lose control.
669 Pavement riders set their tire pressures somewhere
670 around 34 front, 36 rear. Those numbers are WAY too
671 high for OR'ing. The tire skips over the top of the
672 gravel and dirt, the tire is too rigid to conform to the
673 surface, and traction is very poor.
674

675 When riding OR, you'll want to reduce your tire
676 pressures by at least 10 pounds so the tire can grip
677 the ground. The easiest way to do this is with a
678 BestRest EZAir gauge. <http://www.bestrestproducts.com/p-44-ez-air-gauge.aspx>
679

680 The EZAir gauge also works as an in-line gauge when connected to the CyclePump. You leave the gauge
681 connected to the tire, then you connect the CyclePump to the input valve stem on the side of the Gauge. The
682 Gauge records tire pressure as it inflates.



683



In the dirt I run my BMW's tires at about 24 front, 26 rear, but in really soft terrain I've gone as low as 12 front, 14 rear. The bike had traction like a John Deere tractor but because the pressures were so low I was careful to avoid any sharp rocks. Hitting a rock in the wrong place can break the airtight seal between the rim and the tire sidewall.

When pressures are low the tire is at risk of being damaged by rocks, sticks or other hazards. It's a trade-off and a calculated risk.

Low pressure = best Off Road traction.
Low pressure = increased risk of puncture or rim damage.

These photos show me making a tire pressure changes. At left I dropped pressures because we were leaving

700 pavement and we were heading out into the Great Basin of Wyoming. At right I was adding air because we were
701 going back on the pavement.
702



703
704
705
706
707
708
709
710
711
712
713
714
715
716
717
718
719
720

If you expect to ride where there's going to be lots of rocks you'll want to keep your pressures fairly high, perhaps at highway pressures of 34 front, 36 rear. Check your motorcycle operator's manual for proper highway pressure.

You'll spend a few hours (or days) riding off road then you'll eventually (and unfortunately) find yourself back on the pavement. When that happens you'll need to air-up your tires again. Running low pressure at highway speeds is a recipe for premature tire wear and/or sudden tire failure. You'll need to have an on-board inflation system so you can restore your tires to highway pressures.

I use the CyclePump. <http://www.bestrestproducts.com/c-10-cyclepump.aspx>. I invented it, I manufacture it, and I sell it around the world. I guess you could say I have strong preference when it comes to tire inflation. Even if I didn't make it, I'd still carry one because in my humble opinion it's the best tire inflator out there (tens of thousands of fellow riders agree). You can buy a cheaper inflator somewhere else, but you can't buy a better one ANYWHERE. I build them as strong and durable as possible, and they're pretty much bulletproof. That's why they come with a 5-Year Warranty.



721
722
723

Yes, I know this was a shameless plug for a product that I manufacture. Please forgive me and consider it as part of the cost of this FREE article.

724 Riding gear

725

726

727 What kind of riding gear should you wear? Riding gear is largely a matter of personal preference. Generally
728 speaking, the type of gear worn by pavement riders ISN'T suitable for OR riding. Similarly, an executive's Brooks
729 Brothers suit and Gucci shoes aren't suitable attire for digging ditches (or maybe they should be?). If street gear is
730 all you have to wear and you can't afford the proper Off Road riding gear, that's another matter, but as soon as
731 possible get the right stuff.

732

1. Leather jackets or pants are too hot for OR'ing, plus they may limit your ability to move on the bike. You'll
733 need to be able to move around, aggressively.

734

2. I recommend textile riding gear that uses Cordura or Kevlar, along with integrated hard plastic protectors
735 in vital areas like elbows, knees, and the spine. Spend enough money to get quality gear. Don't buy
736 cheap gear just because of the price. It won't last and it won't perform. You're better off investing in
737 quality gear that costs more. Believe me, I've learned this lesson the hard way. I've bought gear based
738 on price, only to discover that the gear was low quality and not up to the task. Before long I had to replace
739 it with something better. And I had to learn that lesson again and again. Ad nauseum. Looking back I
740 now see that if I'd bought the BEST gear the FIRST time, I'd be hundreds of dollars ahead today.
741 Reminds me of the old saying, "You get what you pay for."

742

3. Helmet – get one with chin bar (full face). You'll need to protect your face in the event of a tumble. Open
743 face helmets won't provide adequate protection. I like the Arai XD, but a Shoei or a Nolan flip face is good
744 too. Just make sure you flip down and lock the chin bar down before you start riding OR.

745

4. Goggles – you'll need them if you're going to be riding in lots of dust (stirred up by other riders). Another
746 reason I like the Arai XD is that I can use a pair of goggles or the face shield, depending on conditions.
747 Most flip face helmets don't give you a large enough opening for goggles to fit.

748

5. Air Flow - Select a helmet with good flow. You're going to get hot when you ride OR, so you want to have
749 cool air blowing on your face. Your riding apparel should also have good ventilation. Zippered vents,
750 mesh fabric, etc.

751

6. Eye protection - don't ride with your eyes exposed.
752 You have a greater chance of getting something in your
753 eye when riding OR, than you do on pavement. I
754 NEVER ride without eye protection, whether it be
755 goggles or a face shield on my Arai helmet. I've got a
756 lot of scratches on my face shield and goggles from
757 branches and other debris.

758

7. Jacket with armor in the elbows and along the spine. I
759 wear the BMW Rallye jacket, but Klim has great gear
760 too. Bring lots of money when shopping for riding
761 apparel. Remind yourself that your investment will last
762 for years and it'll give you maximum comfort and
763 protection. Unfortunately it's hard to find good quality
764 riding gear in my size – SF (Short and Fat).

765

8. Alternative to a riding jacket – wear a polyester jersey
766 and a plastic chest/spine protector with shoulder pads
767 and elbow pads, plus knee pads. This setup is more
768 akin to what a motocross rider wears. A jersey is
769 cooler in hot conditions than an expedition jacket.

770

771

772

773

774

775

776

777

778

779

That's me on the KTM. I may look silly but I'm well protected.



- 780
781
782
783
784
785
786
787
788
789
790
791
792
793
794
795
796
797
798
799
800
801
802
803
804
805
806
807
9. Elbow pads that strap to your arms, if your jacket doesn't already have them in the sleeves.
 10. Pants with hip pads and kneepads. If your pants don't already have kneepads sewn in, get some aftermarket pads that'll strap on. You can also get padded bicycle shorts that will give your hips some protection. You're going to hit the ground at some point, so its wise to protect both knees and hips.
 11. Boots with good ankle and arch support. Street riding boots are not a good choice - they lack proper ankle support and the arch is not strong enough when it comes to standing on the pegs. The boots must come up high enough to protect your shins. Boots with zipper closures don't cinch the boot tight enough to support your foot and ankle. Instead you'll need a boot with heavy-duty adjustable buckle closures. A heavy steel arch is very important because you'll be standing on the pegs for long periods of time. If the arch support is too is weak, your feet will suffer badly.
 12. Gloves - heavy duty, with hard impact protection sewn onto the tops of the fingers and thumb. The palm should be smooth, without seams or wrinkles that will cause blisters. The wrist should have a hook and loop cinch strap so the glove can be secured firmly around the wrist. My gloves are fairly short, ending just above the wrist, without long gauntlets. When buying gloves, make sure they're perfectly comfortable when gripping a handlebar. Don't buy them if they cause any constriction to hands or fingers.
 13. Rain gear – you'll need to have something to keep you dry when the heavens open up. Removable Goretex liners for your jacket and pants are nice, but the downside is that you have to take off your jacket and pants to put on the liners. When it does rain the outer layers get soaked and they stay that way for the rest of the day. I like Frogg Toggs brand rain gear because it packs down tightly in very little space and it fits over my bulky OR riding gear. When the sun comes out, I peel off the Toggs and my riding gear is still nice and dry. Frogg Toggs also provide some measure of warmth on a cold ride because they cut the wind. <http://www.froggtoggsraingear.com/index.htm>

Physical Conditioning

- 808
809
810
811
812
813
814
815
816
817
818
819
820
821
822
823
824
825
826
827
828
829
830
831
832
833
834
1. Good physical conditioning is important. The better shape you're in, the easier it'll be to ride OR. If you're a couch potato, then your OR riding experience will be exhausting. When you're exhausted, you make mistakes. When you make mistakes, you fall down. When you fall down, you ...get... hurt.
 2. Your legs need to be in good enough shape that you can stand on the pegs for long periods, and so you can absorb the bumps and changes in terrain. The physical demands are similar to downhill skiing, but unlike skiing, when your riding OR there's no chalet at the bottom of the hill where you can rest up and sip hot chocolate and flirt with the cute snow bunnies.
 3. Upper body strength is important – you'll be moving the bars with your arms, plus you'll be using body language to help control the direction of the bike.
 4. You don't need to be a body builder, but the better condition you're in, the easier off-road riding will be.
 5. Bring what you have in the way of body conditioning, and make adjustments as needed. After a day of riding OR you'll be wishing you'd spent more time in the gym, less time on the couch.
 6. I break the rules when it comes to body conditioning. Admittedly lazy and fat, I know I should get in better shape before I ride. Recognizing my limitations I don't over-exert myself. I'm convicted that I need to do a better job of physical conditioning. Maybe when I finish writing this Article I'll take my own advice and get off my butt... (Update – after publishing the first issue of this Article, my conscience kicked in and now I'm working out regularly and getting in better shape. If this short, fat boy can do it you can too. A good way to start is to read this article while you're walking on the treadmill.)

835
836
837
838
839
840
841

Equipment To Carry On The Bike

1. HelmetLok and Cable. If you leave the bike to eat in a restaurant or shop in a store for vittles, you'll want to secure your helmet and/or jacket. You can also use the HelmetLok for light duty applications like holding up a tent rope or a clothesline. <http://www.bestrestproducts.com/c-159-helmetlok.aspx>



842
843
844
845
846
847

2. Motorcycle Recovery System (MRS) – a rope and pulley system designed to help you recover your bike in the event you “park” it in a way that you can’t get it back up on the road or trail. Also good for towing. (see the Towing Section of this article) <http://www.bestrestproducts.com/c-168-recovery-gear-mrs.aspx>



848
849
850
851

We used the MRS to haul our KTM's up a section of near-vertical trail at a bridge wash-out. We tried riding up the slope but it kicked our butts and spit us out. Using the MRS we had both bikes up the far bank in minutes, without breaking a sweat. Yes, the same setup would've also worked with bigger bikes like the R12GS.



852
853

For a YouTube video showing the MRS in action, click this link:

854
855
856
857
858
859
860
861
862
863
864
865
866
867
868
869
870
871
872
873
874
875
876
877
878
879
880
881
882
883
884
885
886
887
888
889
890
891
892
893
894
895
896

<http://www.youtube.com/watch?v=1DnDCWvVEag>

3. Tow rope. The Motorcycle Recovery Kit can accomplish this task. Otherwise, carry a nylon strap that's long enough that your buddy can tow you back to civilization. See the section on towing another bike.
4. Road flare. For signaling to others or for starting a campfire in an emergency. I wrap the flare with plastic and duct tape to protect it from the rain, then I zip tie the flare to the frame.
5. Water. You can carry it in a Camelbak hydration backpack, or somewhere on the bike in a bottle or jug. You'll need to constantly rehydrate as you ride OR. If you don't, you'll suffer headaches and your physical performance will quickly decline. I prefer filling my Camelbak with water, not Gatorade or some other sports drink. You can't use those sweetened fluids to wash your face or clean a wound.
6. Snacks. Even though this chapter covers Gear, it's my belief that a few snacks make up an essential part of your everyday riding kit. I throw in a couple granola bars and a small bag of jerky. Those small snacks keep me performing after being in the saddle for a few hours. Without them my performance declines.
7. Flashlight. Your plans may include an overnight stay, but even if they don't you'll want to have a flashlight in your kit, just in case you get stuck on the trail after dark. I carry two light sources – a Petzl headlamp (from REI), and an LED Surefire flashlight. I use the Petzl for setting up camp and when reading in the tent, and I use the Surefire light as a long range spotlight. It's amazingly bright and the beam is tightly focused, but it's very expensive at over \$100. The good thing about LED lights is that they last for hours and hours with very little battery drain.
8. Fuel. Plan your fuel carefully and make sure you have enough to get from Point A to Point B. Many riders carry spare fuel containers in MSR bottles, or in some other container. One solution for carrying fuel (or water) is the PegPacker. <http://www.bestrestproducts.com/c-114-pegpacker.aspx>
9. Shovel. You may need to dig the bike out of the dirt, or you may need to reconstruct a section of trail so you can make passage. I've done that very thing a number of times. My favorite shovel is the folding Glock entrenching tool. It incorporates a shovel, a rudimentary axe (sharpen one edge), you can use it as a hammer, plus the handle contains a saw that'll cut thru branches up to about 8". Costs about \$40 on Amazon.
10. Axe or cutting tool. Used for cutting campfire wood or for cutting trees or branches that have fallen across the trail. See #6 above. Depending on where I'm riding I also carry a small hand-operated chain saw. It's a couple feet of chain saw chain with handles on each end. I've used it to cut to clear trails of fallen trees when riding in the forests. Fits in a small pouch about the size of a soft ball. The manufacturer has a short video showing how it works. http://www.ultimatesurvivaltech.com/ust_website/root/sabercut_saw.html



897
898
899

Another cutting tool is the Sven Saw (above right). Saw components store within the red aluminum

900
901
902
903
904
905
906
907
908
909
910
911
912
913
914
915
916
917
918
919
920
921
922
923
924
925
926
927
928
929
930
931
932
933
934
935
936
937
938
939
940
941
942
943
944
945
946
947

handle. It quickly assembles into a 15" triangular buck saw that easily cuts thru branches and other obstacles. I strap one of these saws on my KTM when I'm riding the trails of northwestern Washington. Available at REI and other sporting goods stores. <http://www.svensaw.com/>

11. Tankbag. Keep it small. I like (and I use) the Wolfman Enduro tankbag because it mounts forward on the tank and because its small enough that it doesn't get in my way. If you can't stand on the pegs without the tankbag hitting you in the groin, then it's too big. Remember that your lower regions will probably come into contact with the tankbag at some point during your travels, so keep the items in the bag small and keep them soft. A large hard camera might not be the best thing to become intimately familiar with, in the event of a tumble.



12. Tank panniers. This means over-the-tank saddlebags. They have soft straps that go across the tank and two storage pouches on either side. Wolfman makes a good system. I like tank panniers because they allow you to move some of your load forward, keeping the bike balanced. I carry these items in my tank panniers: a CyclePump, 1st aid kit, rain gear, personal protection device (bear spray and/or firearm), a few tools, and a water bladder. <http://www.bestrestproducts.com/p-281-basic-tank-panniers.aspx>



13. Duffel bags. You can get waterproof bags from a variety of suppliers. I sell bags made by Ortlieb and Wolfman. Each has its own merits. You decide what's best for your situation.

Ortlieb <http://www.bestrestproducts.com/c-107-ortlieb-bags.aspx>

Wolfman <http://www.bestrestproducts.com/c-155-wolfman-luggage.aspx>

14. I use a small Ortlieb Rack Pack on top of each pannier. One holds my sleeping bag and the one other holds the air mattress and folding chair. <http://www.bestrestproducts.com/c-107-ortlieb-bags.aspx>
15. I use a medium Ortlieb Duffel across the back of the bike, on the luggage rack. It holds my clothing, camp shoes, and other gear. When riding 2-up I orient the bag left-to-right. When riding solo I orient the bag along the centerline of the bike.
16. Tie down straps. Rok Straps are excellent for securing gear. I've used them for years and they've never failed me. Recently I also started selling Gotcha! Straps, which are wide hook-and-loop straps. I like using them for big duffels, and for securing the entire pannier to the frame for extra security and stability. Check the section on securing gear to your bike for photos.
 - a. Rok Straps <http://www.bestrestproducts.com/c-120-rok-straps.aspx>
 - b. Gotcha Straps <http://www.bestrestproducts.com/c-166-gotcha-straps.aspx>
17. I also carry one of those goofy octopus bungee nets (8 hooks). It's useful for temporarily strapping on a bag of groceries after a supermarket visit, just before I head for a motel or a campsite. I'm keenly aware of the hazards of bungees and their hooks, so I'm extra careful when strapping down my groceries. I don't want to lose an eye in the process.

948
949
950
951
952
953
954
955
956
957
958
959
960
961
962
963
964
965
966
967
968
969
970
971
972
973
974
975
976
977
978
979
980
981
982
983
984
985
986
987
988
989
990
991
992
993
994
995
996
997
998
999
1000
1001
1002
1003

Camping Gear

Although this is an Article on Off Road Riding, I'd be remiss if I didn't mention camping gear. After all, one of the purposes of OR'ing is to be able to take the bike to the places you'd like to camp.

This photo was taken on the CDR, somewhere in New Mexico. There wasn't a soul around for 100 miles. I like that.

Quite frankly speaking, this photo captures what Adventure Riding is ALL about. We rode long and hard and now we're enjoying the fruits of our heavy labors.

As we sat around the campfire we discussed the day's journey, both the good parts and the bad parts. We watched the stars, we talked about life and family, and we savored the experience. After an exhausting day on the trail we slept like logs. Not even the other guy's snoring kept us awake.

Setting up camp doesn't take me very long, perhaps 15 minutes. That includes the time needed to pull off my riding gear, pitch the tent, blow up the air mattress, roll out the sleeping bag, and get things ready to cook dinner. If you think I'm quick, my buddy Steve's even faster. I swear he once set his entire camp before I was even able to climb off my bike. Setting up camp quickly and efficiently comes with practice. You shouldn't be at the bottom side of the learning curve when you're on top of a mountain, and the sun's going down, and you're setting your tent for the first time. Instead you should be fully practiced and prepared before leaving home. This rule applies to ALL your gear.

Here's a list of what I take in the way of camping gear. Your list may be longer or shorter, depending on those things you think are important, and which amenities you require when camping on the trail.

1. Tent. I use a 2-man tent which gives me enough room to hold both me AND my riding gear. Because I seldom camp in winter conditions I selected a lightweight summer tent. It has large vents at the top and a waterproof fly. Not the warmest thing for a shelter, but adequate for a night on the trail. It packs small.
2. Ground cloth. I carry an old nylon Army poncho. It doubles as a rain cover for me, and also protects the bottom of the tent from water and dirt.
3. Sleeping bag. I like Big Agnes bags because they have a dedicated slot for my air mattress. Because I ride in the Pacific Northwest, I selected a sleeping bag that will keep me warm down to 32F.
4. Pad, air mattress, or cot. I'm getting too old to sleep on the hard ground. There's nothing worse than spending a sleepless night because a pine cone is boring a hole in my back. I use two different "sleep systems".
 - 1.) if I'm camping for a single night I use a 2.5" thick Big Agnes air mattress that slips into the underside pouch of my Big Agnes sleeping bag.
 - 2.) if I'm camping for multiple nights I use a SleepRite cot. This cot has become my favorite because it provides ultimate comfort and support. It packs down and fits in a pouch 6x8x18 and weighs 5 pounds. See photos next page. <http://www.bestrestproducts.com/p-371-sleeprite-cot.aspx>





1004
1005
1006
1007
1008
1009
1010
1011
1012
1013
1014
1015
1016
1017
1018
1019

5. Air mattress inflator (when using an air mattress). I've tried 12v inflators, hand pumps, foot pumps. I finally settled on the good ol' Mark 1 / Model 1 mattress inflation system – it uses personal lung power. It takes me about 20 strong breaths and the mattress is comfy.
6. Flashlights. I've already mentioned them in the section called "Gear To Carry On The Bike". I carry two LED flashlights. One is a headlamp model, another is an aluminum spotlight. The headlamp version is very handy when setting up camp in the dark, and at 3:00 in the morning when Nature calls. You'll need both hands free so the headband is important. The spotlight is useful for long range illumination. I can see the coyotes 100 yards away, the lions and tigers and bears (oh my!) even further.
7. Small stove. I like the Jet Boil stove because it boils water in about 2 minutes. Boiling water forms the foundation all my camp cooking. I store my stove inside an expandable storage tube which holds the stove and a spare bottle of gas. <http://www.bestrestproducts.com/p-323-storage-tubes.aspx>



1020
1021
1022
1023
1024
1025
1026
1027
1028
1029
1030
1031
1032
1033
1034
1035
1036
1037
1038

8. Camp cuisine consists of rehydrated food, dried snacks, and some fresh fruit I purchase along the route. Hot water is necessary for my morning coffee...lots of it. I used to brew coffee using fresh grounds and a plunger, but now I use small pouches of Starbucks concentrate because it's easier to make (not because it tastes better). I remind myself that I'm roughing it out in the woods so I have to make some compromises in the coffee department. Ah, the price we pay for adventure!
9. Cooking gear. All I need is a container to boil water (the Jet Boil stove will do the job nicely) plus I have a plastic cup for my coffee or an adult beverage. I don't carry pots or pans because I don't need them.
10. Bowls. I carry 2 bowls - both are high temp silicone. They can hold freezing or boiling liquids, act as a bowl or a cup, they nest within each other, and they're squish-able in the saddlebag so they take up very little space. The largest is about the size of a softball. I got them at REI.
11. Plate. I seldom use one, preferring to eat out of the freeze dried food pouch or out of a can, but I do carry an Orikas folding plate/bowl made of a sheet of thin plastic. It takes up no room at all because it's only as thick as a sheet of paper. It doubles as a cutting board.

- 1039
1040
1041
1042
1043
1044
1045
1046
1047
1048
1049
1050
1051
1052
1053
1054
1055
1056
1057
1058
1059
1060
1061
1062
1063
1064
1065
1066
1067
1068
1069
1070
1071
1072
1073
1074
1075
1076
1077
1078
12. Eating utensils. I always have a Swiss army knife for cutting things and for doing my MacGyver imitation, plus I carry a Spork (combination spoon/fork). I've made chopsticks out of twigs. Real Boy Scout stuff!
 13. Water. I carry a tiny bottle of water purification tablets (which I've never needed to use), plus I have a Steripen ultraviolet wand for sterilizing any questionable water found along the way. Check REI for the Steripen. I don't carry a purification pump. I don't carry hard sided water bottles. Instead I carry a water bladder made from an old box of wine. Enjoy the wine before your motorcycle trip then rip off the box and retrieve the inner bladder. Pull the spigot off the plastic liner and flush the insides with soap and baking soda to remove any residual taste. The bladder fits in my tank pannier or saddlebag. It collapses flat when empty and expands as needed when full. I carry 2 empty bladders which means I can carry up to 2 gallons of water. I fill up at the last town I'm passing thru for the day, so I don't have to carry all that water all day long. I've camped for a couple days in places where no water was available for miles around, so having that much water was a blessing to me and to others.
 14. Snacks. Granola bars, dried jerky, instant oatmeal, dried trail mix, fruit, pudding cups, and other non-refrigerated goodies.
 15. Dehydrated food. Shop online at REI or go to your local sporting goods store and pick up a few freeze-dried entrée pouches. I like the version that feeds 2 people. At the end of the day I'm pretty hungry. I usually don't carry more than 1 or 2 pouches. I can always buy more along the route; almost every small town has a sporting goods or general store.
 16. Small spade. If you don't want to carry a Glock shovel, carry a small metal spade with a folding handle. It's a necessity when digging a small trench around your tent for rain runoff, or a hole for your toilet needs. Cover up when you're done because it's the right thing to do.
 17. Toilet paper. Need I say more? Wrap it in plastic to keep dry, and always pack it toward the top of your gear so it's easy to find when you're in a hurry.
 18. Bug repellent. I like Off! Deep Woods brand pre-moistened towelette wipes that come in small soft pouches. I carry a pouch in my jacket pocket and a few in my tankbag. When I'm done wiping hands and face, I take the used towelette and tie it to my hat to keep bugs off my noggin. As an alternative to liquid repellents, get clothing that has the bug repellent chemicals impregnated into the cloth. I've got some Buzz Off gear from Ex Officio that works great.
 19. Folding bucket or bowl. I carry an Ortlieb 5L folding bowl/basin. It folds down nice and small, but expands and so it can carry about a gallon of water. I use it to ferry water from a stream or from the campground pump. I can use it for washing dishes or cleaning up after a day on the trail. Here I am on the Continental Divide using the folding bowl for a shave and cleanup. The passenger seat and saddlebag lids make for a good working platform.



1079
1080

1081
1082
1083
1084
1085
1086

20. Chair. Keep it simple and lightweight. You could use your panniers to sit on, like Steve's doing 2 photos above. It might seem that carrying a chair is an extravagance, but at the end of the day it's awfully nice to be able to stretch your back in a comfortable chair. We've tried them all, and this chair is the best one we've ever found: The Joey Chair. It packs down into a small carry bag only 4x4x6. Weight 34 ounces. <http://www.bestrestproducts.com/c-181-joey-chair.aspx>



1087
1088
1089
1090
1091
1092
1093
1094

21. Organization of my camping and other gear within the saddlebags. Instead of throwing everything in the saddlebag and creating a jumbled mess, you can use small different colored stuff bags to hold your gear. Colors help distinguish cooking gear from food, extra socks from tools, etc. As for me, I use StuffBoxxes to hold and organize my gear. Each StuffBoxx is clearly labeled on top so I know what's inside that box. Simple and easy. <http://www.bestrestproducts.com/c-142-stuffboxx.aspx>



1095
1096
1097
1098
1099
1100
1101
1102
1103

22. One important note about your organizing your gear... make sure you know where each item's stored. There's nothing more frustrating than trying to find something you really need, and not finding it. You go thru both panniers and after a 30 minute search you finally find it where least expected. I make a list of my gear, note where it's stored, and I always put that gear back in the same place.

1104
1105
1106
1107
1108
1109
1110

Emergency Gear

Here's a list of "emergency gear" that you should carry for those times when things go badly. If you carry the gear, you'll probably never need to use it. If you don't carry the gear, Murphy's Law will undoubtedly kick in.

1. First Aid kit, with large bandages. Don't pack it in the bottom of your saddlebag. Have it handy.

- 1111 2. Instant ice pack for treating sprains. One of those small instant ice packs made it possible for me to ride
 1112 home after an over-the-bars tumble where I sprained
 1113 my thumb. The ice pack controlled the swelling long
 1114 enough for me to ride home.
 1115
 1116 3. Cell phone – need we say more? At the very least
 1117 you'll be calling home to check in. You won't always
 1118 have a signal but you'd be surprised where I've been
 1119 on the bike, and still had a couple bars on the signal
 1120 meter so I was able to make a call. Carry a spare
 1121 battery and/or a phone charger.
 1122
 1123 4. Spot tracker – satellite transmitter. Push one button
 1124 to summon mechanical assistance or emergency
 1125 help. Especially useful when riding solo. You'll pay
 1126 to buy the transmitter plus there's an annual service
 1127 fee, but it's money well spent. I use it to send
 1128 progress points along my journey, and to let Long Suffering Wife know that I'm OK at specific times of the
 1129 day. This photo shows the cockpit of my F8GS, with GPS, Spot, and a radar detector (there were some
 1130 pavement sections I needed to cross before I hit the dirt)
 1131
 1132 5. Food and water. You may be out there for a while. Be prepared for a stay of at least 24 hours.
 1133
 1134 6. Space blanket. Provides shelter and keeps you warm if you get caught in the field.
 1135
 1136 7. Matches. Storm proof matches that'll light when wet, or at least carry a fresh butane lighter.
 1137
 1138 8. Whistle – you can blow a whistle louder and longer than you can call for help
 1139
 1140 9. Signaling mirror – catch the attention of passing hikers, motorists, or aircraft. Also useful for touching up
 1141 your trailside makeup. It's always important to look your best when you ride OR.
 1142
 1143 10. Medical history – with prescriptions, blood type, etc on a medical USB card.
 1144
 1145 11. Emergency contact info, prominently available in your wallet. EMT's will want to know whom they should
 1146 contact when they find you wandering in the wilds.
 1147
 1148 12. Medications. Take a small supply of your daily meds. Put them in a baggie and clearly label what each
 1149 pill is for. At the end of a long day's ride I find I have trouble remembering what the big white pill is for and
 1150 when I should take it, and how many of the small green pills I need.
 1151
 1152 13. Credit card, some cash (small denominations) and loose change for a phone booth or vending machine
 1153
 1154 14. Some riders put a small sticker on their helmet that lists their blood type. That's helpful for the EMT's.
 1155 Seems morbid but it's still a good idea.
 1156
 1157 15. Medic Alert bracelet or necklace, as needed.
 1158
 1159



Loading Gear On The Bike

1160 Wow! You say – those lists shown above mean you'll be carrying a lot of gear. Yes. But those lists are ones I'd
 1161 use for a weeklong trip or a major expedition. A one-day ride requires much less gear but I'll still need the basics:
 1162 tire repair gear, 1st aid kit, emergency kit, and my basic tools (at the very minimum). Photo at left shows the R12GS
 1163 loaded for the Continental Divide Route. Photo at right shows the F8GS loaded for the same route a year later,
 1164
 1165

1166 going the opposite direction. Notice some similarities? That's because the loading system works really well.
1167 Everything's nice, neat, organized, and securely fastened to the bike.
1168



1169
1170
1171



1172
1173
1174
1175
1176
1177
1178
1179

When I load the bike, I keep heavy loads as low as possible (at the bottom of the saddlebags). I try to distribute gear so the rear of the bike isn't loaded down too heavily. I put light and bulky gear up higher. I strap everything down with two styles of straps:

1. Rok Straps <http://www.bestrestproducts.com/c-120-rok-straps.aspx>



1180
1181
1182
1183

2. Gotcha! Straps <http://www.bestrestproducts.com/c-166-gotcha-straps.aspx>



1184
1185
1186
1187
1188
1189
1190
1191
1192
1193
1194
1195
1196
1197
1198
1199
1200
1201
1202
1203
1204
1205
1206
1207
1208
1209
1210
1211
1212
1213
1214
1215
1216
1217
1218
1219
1220
1221
1222

3. Don't use traditional bungee cords. They'll fail when you need them most. They're also a safety hazard – many people now wear a permanent eye patch because the bungee popped loose as they were connecting their load. The hook slipped suddenly and took out the nearest eyeball. I've nearly had this happen myself. No more bungees for me (except for a small octopus net for attaching a last minute bag of groceries).
4. The more gear you load on the bike, the less responsive it becomes. A 100-pound dancing partner is easier to spin around the floor than a 300-pound heavyweight. More weight means you'll need to work harder.
5. The higher the center of gravity of your load, the more difficult it is to control the bike OR. Keep it as low as possible.
6. The more you load the bike with the weight to the rear, the less stable your steering becomes. Your front wheel won't have good traction. Your rear tire will be pushed to the max when it comes to gross weight.
7. A bike that's loaded heavily in the rear causes a change in riding geometry – your rake increases and you'll feel like you're riding Peter Fonda's Easy Rider chopper. That's not a good thing in the dirt.
8. Without getting into a long discussion about rake and trail and technical things, suffice it to say that as you load your bike, try to do it so that the cargo causes the bike to settle evenly, both front and rear.
9. Adjust your rear shock preload to compensate for cargo. On my bikes I crank the rear shock preload all the way up to max. The weight of my cargo causes the bike to settle down to where the bike sits level.
10. A passenger's weight really has an impact on how the bike rides. You'll have to cut down on gear when you have a passenger on board. If you're camping 2-up this presents some real challenges, but it can be done. A passenger limits your OR capabilities, but they can be useful when it comes time to pull or push. Just ask my Long Suffering Wife.

Gear You Should Carry ON YOUR PERSON (and things you shouldn't)

1. I know a rider who broke 2 ribs because he was carrying a small hard camera in their chest pocket. He showed me the camera – it was slightly larger than a cell phone. Based on that scenario I avoid bulky objects in the pockets of my riding jacket. The camera still worked after the tumble, so I guess that's a good thing.



1223
1224
1225
1226
1227
1228
1229
1230
1231
1232

2. One gal wrote me after reading this Article. She confirmed the importance of not carrying hard gear on your body. She had an SLR camera slung around her neck when she took a tumble. It broke 6 ribs. She also stressed the importance of keeping your important papers on your person (passport, license, etc). She lost control on gravel, the throttle stuck open and eventually the bike burst into flames, burning all her international travel documents stored in her tank bag. She's fully recovered now and says she'll gladly sell her BMW F650GS twin at a greatly reduced price.

1233
1234
1235
1236
1237
1238
1239
1240
1241
1242
1243
1244
1245
1246
1247
1248
1249
1250
1251
1252
1253
1254
1255
1256
1257
1258
1259
1260
1261
1262
1263
1264
1265
1266
1267
1268
1269
1270
1271
1272
1273
1274
1275
1276
1277

Now don't go and get all paranoid on me – this incident was very unusual and your situation will probably be less dramatic, if it ever does happen. Chances are it never will. Take reasonable precautions, but don't stop riding out of fear because of one person's story. Learn from their mistakes.

3. I only carry soft items in my chest pockets – soft pouches of food, bug repellent, Cycle Wipes lens cleaners <http://www.bestrestproducts.com/c-167-cycle-wipes.aspx>, perhaps a few credit cards and some cash.
4. I carry my wallet in a pants pocket. It's too thick to carry in my chest pocket (see #1 above).
5. I don't carry pens or other sharp objects in my chest pockets. Can you say, "sucking chest wound?"
6. I carry a few small hard items in the lower pockets of my jacket, below my waist. Those items include my wallet and cell phone. (see #1 above)
7. I don't carry a fanny pack because I find it uncomfortable, but some riders like them. Whatever you put in there keep it soft and crushable, lest it cause injury when you make hard contact with the ground.
8. I wear a hydration backpack, which also has outer pockets for small things (whistle, food, mirror, Leatherman tool, etc). Carrying a backpack or a hydration system on your back comes with some risk – the gear inside can cause injury. Try to keep the gear small, try to keep it soft. Your riding jacket should have some type of hard spine protector to guard you against your backpack contents.
9. If I'm going to carry a personal locator beacon (Spot Finder), I usually try to put it in one of the pockets on the hydration pack. That way if I'm separated from the bike I can still summon assistance.

Tools To Carry On The Bike

1. It used to be common for motorcycle manufacturers to provide a rudimentary tool kit with each motorcycle. The kit was usually pretty basic, but at least it gave you the essentials. In today's economy that kit probably isn't included anymore. BMW took this route a few years ago. Now you have to come up with your own toolkit that fits your bikes special bolts and nuts. Once you have the kit you need to carry it with you whenever you ride. It doesn't do you any good if your tools are sitting on a bench in the garage.
2. If you have tubed tires you'll need tools to remove the wheels for tire repair. Practice at home – remove the wheel from the bike using ONLY the tools in the on-board toolkit. Don't cheat by going for your 12-drawer roll-around Nascar Team Special Edition Snap-On tool chest. If you can't remove the wheel with your on-board tools, then you need to supplement your carry-kit.
3. You'll need tools to tighten/loosen EVERY major nut or bolt on the bike that's likely to come loose, or that might need adjustment. That includes the pinch bolts for the handlebars. I once had the handlebars come loose on a forest service road, as I rode a primitive road between St. Maries ID and Missoula MT. It was real feat to maintain control with a set of handlebars that rotated forward to the headlight, and rearward into my lap. As soon as I got to the next town I bought a set of allen wrenches, which I still carry.

- 1278
1279
1280
1281
1282
1283
1284
1285
1286
1287
1288
1289
1290
1291
1292
1293
1294
1295
1296
1297
1298
1299
1300
1301
1302
1303
1304
1305
1306
1307
1308
1309
1310
1311
1312
1313
1314
1315
1316
1317
1318
1319
1320
1321
1322
1323
1324
1325
1326
1327
1328
1329
1330
4. You'll need tools for periodic maintenance if those maintenance intervals fall during the time you're on your journey. In other words, if you plan to change oil during your ride to Alaska, take the tools you need to do that task. But you don't need to carry all those tools if you're just doing a 2-day ride in the hills.
 5. Compromises must be made when it comes to an onboard toolkit – you simply can't carry everything under the sun, so you have to make an educated guess and carry an assortment of tools you're most likely to need. A flywheel puller probably isn't needed but a Leatherman multi-tool would be.
 6. Electrical tester (volt-ohm-continuity), male/female splice connectors, and a few pieces of electrical wire
 7. Electrical tape for covering up those emergency wiring projects.
 8. Gaffer tape and/or duct tape. You can make temporary repairs to windscreens, saddlebags, etc.
 9. Zip ties – these are absolutely essential because they can be used for hundreds of purposes. One time I used them to hold the headlight in place after it came off when I was riding thru an abandoned railroad tunnel.
 10. Siphon hose to “borrow” fuel, or to share fuel with others. If you bought Dyna Beads to balance your tires, you can use the empty hose as a siphon tube. <http://www.bestrestproducts.com/c-100-dyna-beads.aspx>
 11. JB Weld (epoxy) for repairing holes in engine cases or other surfaces. Make sure you get the 5 minute quick-dry type, not the 24 hour overnight curing type.
 12. Small tube of Super Glue. You'd be surprised how handy it is. But once you open the tube you should probably plan on replacing it with a new one. My experience is that the 2nd time I want to use it the glue has hardened. This only happens in the field, never in the garage. Must be a Murphy's Law thing.
 13. Small vial of multipurpose grease for cables, levers, etc. No vial? Use a tiny plastic baggie.
 14. Small aerosol dispenser of WD40. This can also act as a starting fluid or a fire starter.
 15. Small hammer – a ball peen type, with a 4” handle (you'll need to cut down the handle yourself)
 16. Small file about 3-4” long, for easing sharp corners, filing down bolt heads, etc.
 17. Vice grips and/or pliers for gripping or cutting. I carry a pair of Knipex pliers, available from Aerostich.
 18. Short piece of hack saw blade. You can hold the blade with the vice grips.
 19. Small assortment of common wrenches 8-10-11-12-13-14-15 mm, or as needed for your bike
 20. Allen (hex) or torx wrenches as needed for your bike.
 21. Leatherman multi tool (or similar brand). This is a MUST-HAVE item.
 22. Assorted nuts and bolts in common sizes. A few 8mm, 10mm, etc.
 23. Spare container of motor oil wrapped in heavy duty ziplock bags. It's not a good idea to carry oils in the same saddlebag as your clothing, in case of spillage. Consider using OilJugs because they're smaller than a 1-quart bottle of oil. I carry gear lube in 1 jug, oil in another jug, and medicinal spirits in the 3rd.
<http://www.bestrestproducts.com/c-24-oil-jugs.aspx>



1331
1332
1333
1334
1335
1336
1337
1338
1339
1340
1341
1342

- 24. Special parts your bike might need to fix known issues or weak points. If you ride an BMW R12GS you might carry a spare sight glass cover and alternator belt. Your particular bike might need a special wrench needed to fix/repair/adjust the rotary frammis or the cylindrical galvinator.
- 25. If your bike has a chain drive, bring an extra master link, a short (3-4") section of chain, and a compact chain breaker tool.
- 26. All of my basic tools fit into this one StuffBoxx. The box actually contains more tools than shown in the right photo. I laid out the important bits for you to see. I also carry some specialty tools not shown.



1343
1344
1345
1346
1347

Another tool storage method is to use these expandable plastic containers
<http://www.bestrestproducts.com/p-323-storage-tubes.aspx>



1348

1349
1350
1351
1352
1353
1354
1355
1356
1357
1358
1359
1360
1361
1362
1363
1364
1365
1366
1367

27. Inner Tubes. Although inner tubes are technically not “tools”, you need to think of them as a tool because they’re used to fix a problem. When you carry tubes you need to protect them from damage caused by chafing inside the saddlebag. I know of one rider who carried tubes across Siberia, and when he needed them he found them unusable because they had abraded inside their cardboard box. Carefully wrap the tubes so that they’re in perfect condition when you need them.

A good item to use for carrying tubes is the StuffBoxx. They’ll hold two tubes, depending on the size of the tire. <http://www.bestrestproducts.com/c-142-stuffboxx.aspx>

Tire Repair Tools

The single most common problem you’ll encounter in the field is a tire puncture. Flat tires seldom happen in front of a motorcycle repair shop, so you’ll need to be able to fix it yourself. The good news is that it’s really not that hard. You can learn how to change your own tires and make basic tire repairs by watching the BestRest Tire DVD. <http://www.bestrestproducts.com/p-291-bestrest-dvd-tire-changes-and-repairs.aspx>



1368
1369
1370
1371
1372
1373
1374
1375

1. Tire repair kit - tubed or tubeless depending on your bike. I like the Universal Tire Repair Kit because it repairs both types of tires. I ride a variety of bikes (some with tubes, some tubeless) and this kit gives me the ability to repair any style. The hard plastic storage tube at right keeps everything organized, and prevents the tube of glue from getting squished in the pannier. <http://www.bestrestproducts.com/p-236-universal-tire-patch-kit.aspx>



1376
1377

- 1378 2. Learn how to make your own tire repairs and practice BEFORE going into the field. Get an old tubeless tire
 1379 and tube and spend a few minutes practicing. Watch the DVD mentioned above.
 1380
- 1381 3. Carry spare inner tubes (front and rear). Even though I have tubeless tires on my R12GS, I still carry a
 1382 tube for emergencies. If the tubeless tire has a large cut in it, I can put a tube inside the tubeless tire and
 1383 still make it back home. If I only have room to carry one tube, I carry the front tube because I can use it in
 1384 front tire, or I can stuff it in the rear tire even though it's a larger circumference. If I'm carrying a rear tube
 1385 only, I can't make it fit the front tire in an emergency. Remember to protect the tubes in the saddlebags, so
 1386 they're not damaged by chafing or saddlebag vibration. I put my tubes inside a StuffBoxx.
 1387
- 1388 4. Method of tire inflation - 12v inflator, hand pump, CO2, etc. Once the tire is repaired you'll need to inflate.
 1389 You can use a hand pump or an electric inflator. The CyclePump is my preferred method.
 1390 <http://www.bestrestproducts.com/c-10-cyclepump.aspx>
 1391
- 1392 5. CO2 inflation? At BestRest we've tested CO2 cartridges and we found them to be unsuitable for OR'ing.
 1393 They weigh a lot, they don't fully inflate the tire, they're surprisingly unreliable, and they cost a heck of a lot
 1394 of money. One inflation of one tire can cost you almost \$50 bucks. Ouch! Carrying CO2 is better than
 1395 having nothing at all, but not by much. The charts below show the size of the cartridges, the pressures we
 1396 achieved, and the costs for one fill-up. To see all the data click the link below then scroll down the page for
 1397 a report on CO2 cartridges. You'll see how well they worked (or didn't work).
 1398 <http://www.bestrestproducts.com/p-265-beadsetr-white-paper.aspx>
 1399

16 gram cartridges	PSI achieved	Cost to inflate to indicated pressure
3	18.5	\$26
6	35.5	\$38
9	51.5	\$48

Costs based on kit pricing. Refills only available in 3-paks.

45 gram cartridges	PSI achieved	Cost to inflate to indicated pressure
1	13	\$45
2	27.5	\$45
3	42.5	\$75

Costs based on kit prices. Refills only available in pairs. Ya' can't buy 3, we had to buy 4.

- 1400 6. A bead breaker to get the tire off the rim. Don't assume you're going to use the sidestand to break the
 1401 bead, especially if you're traveling alone. Remember, one tire is going to be removed from the motorcycle
 1402 when you're working on the other one. You'll be doing a balancing act with the bike, while you try to make
 1403 that sidestand break the bead. I consider the sidestand bead breaking technique to be an "urban myth".
 1404 There's a lot of talk going around about using the sidestand to break a bead, but few riders have ever
 1405 actually done it. Many have tried and failed. It sounds good in theory, but in the real world it's an "iffy"
 1406 technique. If that's the method you actually do use in the field, and you've REALLY done it on both tires by
 1407 yourself, then you get a big gold star. As Cary Grant once said in a movie, "You're a better man than I,
 1408 Gunga Din." Whatever method you use, practice with it before you leave home, using only the gear you're
 1409 actually going to carry on the bike. And don't cheat by doing it on a smooth concrete floor; that surface is
 1410 seldom handy when riding in the field. Do it on your lawn or in a patch of dirt, like you'd find on the trail.
 1411
- 1412 7. For my own bead breaking chores, I use the BestRest TireIron BeadBrakR because it gives me everything I
 1413 need to break a bead, change a tire, and make repairs in the field, anywhere, every time, under any
 1414 conditions. I don't rely on the sidestand to break the bead; instead I rely on this foolproof tool that easily
 1415 breaks the bead on every bike. <http://www.bestrestproducts.com/c-98-beadbrakr.aspx>
 1416
 1417
 1418



Above photo shows the standard BeadBrakR pouch.

You can now order it with the TCM (Tire Changing Mat) pouch. See below.

1419
1420
1421
1422
1423
1424
1425
1426
1427
1428
1429
1430
1431
1432
1433
1434
1435
1436

8. You'll need tire irons to remove the tire from the rim. You'll also need to know how to use those irons. It's all about technique, not about brute force. Three tire irons that are 8-9" long are sufficient, anything longer than that is overkill. Are longer irons handy? Yes. Are they necessary? No. You can learn how to use short tire irons by watching the Tire DVD.
9. Fixing flats on tubeless tires uses different techniques than fixing flats on tires with inner tubes. I could write a book on both types of repairs, but it would be easier if you just watched the DVD. A picture's worth a thousand words, a DVD's worth a million, and my fingers are getting tired of writing about it.
10. You'll need mounting lube for tubeless tires, or talcum powder for tires with inner tubes.
 - a. BeadGoop for tubeless tires <http://www.bestrestproducts.com/c-132-bead-goop.aspx>
 - b. TalcTube for tubed tires <http://www.bestrestproducts.com/p-292-talctube.aspx>



BeadGoop for tubeless



TalcTube for tubes



TalcTube strapped to frame

1437
1438
1439
1440
1441
1442
1443

11. When working on a tire in the field, it's REALLY helpful to have a clean and organized tire changing mat. We created the BestRest TCM (Tire Changing Mat). It serves many purposes: It holds a TireIron BeadBrakR in a convenient pouch, it can act as a Tire Changing Mat, it can be used as a tablecloth or picnic table cover, it can be used as a rain cover for you seat or your instruments, and it can be used as a porch in front of your tent.



1444
1445
1446 These photos show the TCM unfolded, then rolled with a BeadBrakR inside. Tie down loops at all 4 corners
1447 make it easy to stake down or tie to the bike.
1448

1449 **Repairs On The Trail**

1450
1451 If you ride a motorcycle long enough you're going to have a breakdown along the trail. It happens to everybody,
1452 regardless of the brand you prefer (BMW, KTM, Kawasaki, etc.) Don't laugh at the guy aboard that Brand X
1453 motorcycle that just broke down – you're next on Murphy's list. Tomorrow he'll be laughing at you.
1454

1455 You can minimize your chances of a breakdown by keeping your bike in good condition and making sure you follow
1456 the manufacturer's service recommendations. Get your valves adjusted, fluids changed, etc. before you head out in
1457 the hills. It makes sense to take care of the bike, so it will take care of you. If you neglect your pony, she'll buck
1458 you off and leave you stranded in the middle of Nowhere. When you're stranded in the middle of Nowhere, wild
1459 animals are going to chase you down and pick your carcass clean. Get the point?
1460

1461 Don't add an accessory or make a major change to your bike the night before your big Off-Road Adventure. If you
1462 make changes give yourself enough time to take the bike for a few test rides, sort of like a "shake-down cruise" so
1463 you can work out all the bugs. You may find that your new farkle isn't working properly, or that it's more of a
1464 headache than it is a helper.
1465

1466 Your pre-ride inspection is your best opportunity to look for these types of things: loose components, fatigued
1467 brackets, oil seepage, electrical faults, etc. Sprockets showing signs of wear? Oil level low? Brake reservoir low?
1468 Brake pads getting thin? Battery on its last legs? Intermittent electrical problems?
1469

1470 A post ride inspection and cleaning session also helps you identify potential problems. Oil leaks show up easily
1471 when there's a thin coating of dust on the engine. Your bike's trying to tell you something – you need to look and
1472 listen. Most mechanical faults give you warning long before a complete failure actually occurs.
1473

1474 Breakdowns fall into 2 categories – those you can fix yourself, and those you can't.
1475

1476 Examples of things you CAN fix in the field:

- 1477 1. Tire puncture – see next main topic below
- 1478 2. Loose/missing nuts and bolts – tighten or replace
- 1479 3. Cables out of adjustment – adjust to mfg's specs
- 1480 4. Levers out of adjustment – adjust for proper engagement
- 1481 5. Chain tension and chain lubrication – lube and adjust
- 1482 6. Fluid levels low – add oil or gear lube or coolant as needed.

- 1483 7. Broken levers – replace with a spare, or use vice grips on the part that remains
- 1484 8. Broken or split drive chain, see the Terra-X chain breaker below
- 1485 9. Broken wires - splice and wrap with electrical tape
- 1486 10. Punctured engine case - use JB weld to plug the hole, if the hole is small enough
- 1487 11. Fouled spark plug – replace with a spare(s). You're carrying a spark plug wrench, right?
- 1488 12. Alternator failure – replace the rubber alternator belt with a spare
- 1489 13. BMW ignition sensor ring failure – fixable only if you carry a spare sensor that's programmed for your bike.
- 1490 14. Lost key – retrieve the emergency spare key from your super-secret onboard hidey spot

1491
 1492 Here's some photos showing Steve making repairs to his saddlebags. The rough trail caused one saddlebag
 1493 bracket to fail. Fortunately Steve had enough bits, pieces, screws and wire to put things back together again.
 1494



1495
 1496 Here's a couple photos of my rear brake lever that got mashed after kissing a rock. Instead of pointing forward,
 1497 it was bent up at a 45 degree angle. Some creative blacksmithing using a hammer and a rock as the anvil put the
 1498 lever back in operating condition. That field repair has held up for 6 years.
 1499
 1500



1501
 1502 If you have a chain-driven motorcycle then you should be prepared to make chain repairs in the field. Most riders
 1503 don't even think about their chain, except to give it a squirt of lube now and then. But chains can (and do) break in
 1504 the field, or they come off the sprockets because a stick gets wedged in the sprocket. Having a tool that can make
 1505 chain repairs makes all the difference between a minor inconvenience and a major tow bill. I recommend the Terra-
 1506 X chain tool because it can drive out the rivets holding the chain together, and it can alsopeen replacement rivets in
 1507 place. <http://www.bestrestproducts.com/p-330-terra-x-chain-breaker.aspx>
 1508
 1509
 1510



1511
1512
1513
1514
1515
1516
1517
1518
1519
1520
1521
1522
1523
1524
1525
1526
1527
1528
1529
1530
1531
1532
1533
1534

If you can repair a minor issue there's no reason you shouldn't continue your journey. But if the minor issue shows signs of progressing, then it's time to head for the barn where you can make permanent repairs. Don't tempt Fate.

Things you CAN'T fix in the field:

1. Final drive failure – your power train just left the station without you
2. Clutch failure – you can't get power to the wheel, even after adjusting clutch lever and cable
3. Snapped chain – unless you have a spare link and chain repair tool
4. Clogged fuel filter - unless it's an external cartridge like those found on a small trail bike
5. Computer failure - the bike's brain is fried so there's no spark or other electrical
6. ABS failure – the brakes might work but the anti-lock feature doesn't – ride with caution
7. Transmission failure – try to get the bike in a gear that works, then limp home
8. Battery failure – you might be able to limp home, but don't run your lights or other accessories
9. Alternator failure – the diodes are fried so the battery won't charge
10. Bearing failures – probably no field fix is possible
11. Lost key – Don't have a spare? You're screwed, unless you can hotwire the ignition. Good luck.
12. Damaged fuel injectors. Make sure your injectors are protected against trail damage.

In this photo we use a GS-911 module to trouble-shoot a problem with my BMW F800GS. No luck, we had to tow the bike back to camp. You can see the MRS tow rope ready to be deployed. Read more about it in the Towing Section of this article.



1535
1536
1537
1538

If you can't repair the bike in the field you have these choices:

1. Leave the bike and walk to get help (or double-up with your buddy and ride to get help)

- 1539 2. Push the bike to the nearest farmhouse where you can get help or make arrangements to store the bike
1540 3. Call for a wrecker – ask for a flatbed truck, refuse to accept a wrecker with a boom hoist.
1541 Note – here’s where your towing insurance comes in handy. I carry towing insurance thru AAA RV Plus
1542 and I also have a plan thru American Motorcycle Assn. One of them is going to provide assistance.
1543 4. Have your buddy tow you home or tow you to a service center where repairs can be made
1544



1545 You can barely see the tow rope laid out above. We wrote an entire chapter on towing, check the index.
1546

1547
1548 When I’m out riding I’m often wondering how I’ll solve a hypothetical breakdown. If the frammis fails, how would I fix
1549 it? If the gallimeter won’t engage, can I make adjustments? If the rotary protmis comes loose, can I tighten it? If I
1550 don’t have the ability to fix those problems then I make a note to buy a special tool, or otherwise learn how to make
1551 that repair. It seems that because I’m well prepared, I seldom encounter significant breakdowns.
1552

1553 **Tire Repairs**

1554
1555 The most common repair you’ll need to make in the field is when you have a flat tire. Usually the puncture is in the
1556 rear tire. It seems the most likely reason for this is that the front tire rolls over a nail or other obstacle, kicking it up a
1557 bit. The rear tire then impales itself on that object. I’ve seen punctures from nails, screws, fencing staples, railroad
1558 ties, and trailer hitch pins. All were repairable.
1559

1560 Depending on tire design (tubed or tubeless) you’ll use different techniques to repair a tire. One tire repair kit will fix
1561 both styles of tires: <http://www.bestrestproducts.com/p-236-universal-tire-patch-kit.aspx>
1562

1563 Tubeless - If you have tubeless tires it’s a pretty quick and easy fix. Locate and mark the puncture. Remove the
1564 nail or whatever it is that’s sticking out. Use a plugging kit. Re-inflate the tire. The whole process takes about 5
1565 minutes.
1566

1567 Tubed - If it’s a tubed tire you’ll need to remove the wheel from the rim. Put the bike on centerstand. Remove the
1568 entire wheel. Break the tire sidewall away from the rim. Demount one side of the tire from the rim. Pull the tube
1569 out of the tire. Patch the tube. Then put everything back the way you found it. This process can take anywhere
1570 from 15 minutes to an hour.
1571

1572 If you want a full explanation on how this is done, get the BestRest Tire DVD. [http://www.bestrestproducts.com/p-
1573 291-bestrest-dvd-tire-changes-and-repairs.aspx](http://www.bestrestproducts.com/p-291-bestrest-dvd-tire-changes-and-repairs.aspx). The DVD does NOT describe the process of removing the wheel
1574 assembly from your particular motorcycle. For that information you’ll need to read your owner’s manual and/or talk
1575 to your service advisor. Some dealerships put on seminars that teach you how to do this. It seems like the more
1576 you know about tire repair, the less chance you’ll need to actually do it.
1577
1578
1579

1580 **Tire Changes**

1581
1582 I won't spend much time on this topic because in order to cover it properly it I'd have to write a separate Article.
1583 That being said, tire changes aren't really that difficult if you know a few tricks and you have the proper tools.
1584

1585 Tire changing means you'll need to REMOVE the wheel from the motorcycle. Make sure you have the tools to do it,
1586 and practice it at least once before you hit the trail. Don't try to figure it out for the first time when you're up in the
1587 hills. This Article doesn't cover the process of removing your wheel from the bike. Check your owner's manual.
1588

1589 As an OR Rider, it's really helpful (and financially prudent) for you know how to change your own tires. That
1590 knowledge will prepare you for those times when you need to repair a flat tire, and it'll also come in handy when you
1591 need to replace your worn out knobbies. You can learn the techniques you'll need by watching the DVD mentioned
1592 above.
1593

1594 The most important tire changing rule is this - carry the tools you need to do the job. If it's not actually with you on
1595 the bike, then that tool (or tools) might as well not exist.
1596

1597 As far as tire changing tools are concerned, everything you'll need can be found in one compact kit, the TireIron
1598 BeadBrakR. Don't be fooled into thinking that you need to use 18" long tire irons to change tires. Irons that are 8-9"
1599 long give you plenty of mechanical advantage, assuming you know how to use them properly.
1600

1601 You need to take into account whether your bike
1602 balances by itself when you remove a tire for repair.
1603 Does the bike stay up when the rear wheel is removed?
1604 Most of them do because the center stand holds the rear
1605 of the bike, but what happens when you need to remove
1606 the FRONT wheel? Does it fall on it's face like the BMW
1607 F800GS? You'll need to figure out how to stabilize the
1608 bike when you remove either wheel.
1609



1610 The first time I removed the front on my F8GS I was in
1611 for a surprise. I had to put sticks and stones under the
1612 skidplate to keep the bike from falling. I solved the
1613 problem by inventing the ForkStand. Shown at right, it's
1614 a strut that bolts to the brake caliper mounting holes.
1615 With the strut in place the front of the bike is supported
1616 and the wheel can be removed. The components store inside the frame.
1617

1618 <http://www.bestrestproducts.com/p-254-f800gs-bestrest-fork-stand.aspx>
1619
1620

1621 **Off Road Riding Techniques**

1622
1623 OR riding shares the basics of street riding, but there are some BIG differences. It's safe to say that it's easier for a
1624 dirt rider to transition to pavement, than it is for a street rider to transition to dirt. Here's a good analogy: "It's easier
1625 for a camel to fit thru the eye of a needle than it is for a
1626 rich man to enter the Kingdom of God. You get the
1627 point... the same principles apply.... No, it's not impossible
1628 to do those things - it's just harder. Have Faith.
1629

1630 If you're new to the sport of motorcycling don't let your lack
1631 of experience discourage you. These things take time.
1632 Everyone learns at a different pace. Some learn slowly,
1633 some learn quickly. I know of one rider who only started
1634 riding about 2 or 3 years ago. He learned how to ride so



1635 quickly (and so well) that he's now an expert Staff Instructor at RawHyde Adventures. He taught me a few things
1636 about my riding skills and he corrected some bad habits I'd developed. I still have a long list that still need
1637 correcting, but I won't get into those details. I'm a work in progress. So are you.
1638

1639 I can't stress strongly enough the importance of getting professional hands-on training. The techniques I describe
1640 in this Article are just the Beginning. You should take what you learn from these pages, and apply them in a
1641 controlled setting under the watchful eye of professional instructors like those at RawHyde.
1642

1643 I was fortunate - I learned to ride in the dirt long before I learned to ride the street. The subtle techniques I learned
1644 from riding OR easily transitioned to the skills needed on the pavement. Even though I've been riding for more than
1645 5 decades, my OR Riding education hasn't ended. I learn more each time I go out. Actually I think it's more a case
1646 of re-learning what I once knew, but quickly forgot.
1647
1648

1649 **Standing On The Pegs**

1650
1651 Have you noticed that most photos/videos depict off road riders standing on the pegs? They don't do that because
1652 it looks cool, or it makes a better camera shot, instead they do it because standing on the pegs is the only way to
1653 effectively handle a bike when you leave the pavement.
1654

1655 If you're uncomfortable standing on the pegs then that's a fear you'll have to conquer. Proper set-up of your bike
1656 will make standing more comfortable. An understanding of WHY you need to stand will give you the proper
1657 motivation to learn how to stand. Bottom line – you're going to have to do it, so get used to it. If you can't (or won't)
1658 learn the standing techniques then OR riding probably isn't your career choice.
1659

1660 Why do you really NEED to stand on the pegs when riding OR? Why is it NECESSARY to stand when you're riding
1661 on dirt, on gravel, or uneven surfaces? Some will probably disagree with my explanation, but for those of us with
1662 simple minds the following points sense.
1663

- 1664 1. You stand up on the pegs because it allows the bike to move beneath you laterally, forward, and backward.
1665 This range of movement is necessary so that you can initiate turns and maintain balance. When your butt
1666 is glued to the saddle you can't move effectively.
1667
- 1668 2. Pavement riding relies on handlebar counter-steering as well as friction between the roadway and the tire to
1669 turn, brake, or accelerate. There are also several other factors in there such as the change in circumference
1670 of the tire when it's turning, but let's keep this simple. A pavement rider can accomplish everything he
1671 needs to do while he's still sitting on the saddle. A pavement rider's suspension easily absorbs whatever
1672 bumps and dips the highway engineers didn't deem necessary to smooth out and pave over .
1673
- 1674 3. OR riding takes you places where traction is tenuous, at best. Because of this the OR rider has to rely on
1675 Body English to turn, brake, or accelerate. OR roads and trails are filled with bumps, ruts, and other
1676 obstacles that the bike's suspension just can't handle by itself. You stand up because your legs will act as
1677 secondary suspension modules, absorbing the ups-and-downs found along the way.
1678
- 1679 4. Because you're going to be using a lot of "Body English", you'll want to maximize the potential of those
1680 movements. You simply can't do it when your butt is glued to the saddle. When you're seated, you're just
1681 another dead-weight component bolted to the motorcycle. When you're sitting on the seat, your body is
1682 effectively "attached" to the motorcycle and the center-of-gravity (CG) of both bike and rider are combined.
1683
- 1684 5. When you're standing, you become a dynamic and separate entity aboard the motorcycle. When you
1685 stand up, you separate yourself from the motorcycle's Center of Gravity (CG). The bike now has its own
1686 CG, which is down lower, and you've got your own CG, which is a couple feet higher. When standing you
1687 can use your body in ways that will result in maximum leverage to get the bike to go exactly where you want
1688 it to go, and to have it do exactly what you want it to do. Even though your goal is to create maximum
1689 leverage, you'll be using that leverage in subtle and gentle ways, but with great effect.
1690

1691 6. Think of yourself as a tightrope walker who's riding a bicycle across Niagara Falls. If you keep your hands
1692 in your pockets as you peddle across, then your chances of making it to the other side are pretty slim.
1693 However if you're holding one of those long balancing bars then your chances of success dramatically
1694 improve. You'd use the weights at the ends of that bar to compensate for gusts of wind, for body
1695 movement, etc. Similarly, when you stand up on your motorcycle, your body becomes that long balancing
1696 bar.

1697
1698
1699 **Safety Note:** When you're standing on the pegs and riding on public roads, adjust one of your rear view mirrors so
1700 you can see what's going on behind you. If you don't do this you run the risk of being rear-ended, or of moving into
1701 the path of a vehicle that's trying to pass you. I have a close friend who was standing on the pegs and didn't
1702 remember to adjust his mirror. Things nearly ended badly when an 18-wheeler overtook him from behind and
1703 caught him unaware. Adjusting the mirror is equally important when riding forest roads or trails. You don't want
1704 your riding buddy to sneak up from behind and try to pass you, without you knowing that he's coming.
1705

1706 **Five Off Road Riding Positions**

1707
1708
1709 I've learned there are five basic body positions when it comes to OR'ing. Some think #1 doesn't belong in there;
1710 others might want to add or combine some positions. For this Article I'll go with five.

- 1711
1712 1. **Sitting**. I only use this position when things are smooth, straight, level, and I'm not expecting any
1713 surprises. This position makes it difficult to steer or otherwise control the bike when riding OR, so I use it as
1714 little as possible. I consider sitting to be a temporary resting position. As soon as I've rested I stand up
1715 again.
1716
1717 2. **Neutral (standing)**. I'm standing on the pegs, my body is comfortable, my arms are relaxed, my legs are
1718 slightly bent, knees not locked, knees gently pressing against the tank and holding me steady. I can hold
1719 this position for a long time, perhaps a couple hours depending on my physical condition. If I sit down for a
1720 few minutes I can rest and regain my strength, then I go back to the Neutral or Alert! position.
1721
1722 3. **Alert! (standing)** I see an obstacle up ahead and I'm ready for it. I also use the Alert! position when I
1723 need to accelerate, so I shift my upper body further forward than Standing Neutral. This keeps the front
1724 end on the ground and prevents it from lifting. This position is the one used when climbing a gentle hill.
1725

1726 (Some readers might want to combine **Alert!** and **Charge!** into one position because they're very similar.
1727 That's OK with me.)
1728

- 1729 4. **Charge! (standing)** A difficult obstacle is coming up and I'm about to challenge some difficult terrain. In
1730 the back of my mind I hear bugles sounding so I **Charge!** into the battle. There's no time for half measures.
1731 I'm standing on the pegs. I shift my weight forward, anticipating the obstacle. My head is in front of the
1732 handlebars and I can almost look down over the headlight. Arms are flexed and I'm ready to make any
1733 handlebar adjustments. My knees are firmly gripping the tank and are acting as my main connection to the
1734 motorcycle. I'm not tense, but I am prepared for anything. I can only maintain this position for a few
1735 minutes, and then I need to move back to **Neutral** or **Alert!**
1736
1737 5. **Braking/Downhill**. I need to brake or go down a hill, so I straighten my arms (don't lock the elbows), move
1738 my butt back over the rear wheel, and apply the brakes as needed. Keeping my weight to the rear prevents
1739 too much weight transfer to the front wheel, which could cause the front wheel to lock up. This position is
1740 also used when riding down a steep hill. If necessary I'll adjust my body to one side or another, to keep the
1741 bike upright.
1742

1743 As I ride along a road or trail I'm constantly moving from one position to another. Sometimes I do it because it's
1744 necessary, sometimes I do it to just to relieve stress and keep relaxed. Depending on the terrain and my speed, I
1745 can get quite a workout as I move about on the bike. I can always slow down if necessary, catch my breath, and
1746 then pick up my speed again. If I find that I'm getting too tired, if I'm getting cramps, or if my neck gets tense, I stop.

1747 I'll have a drink of water, nibble on a snack, and then I'll get going again. It's supposed to be fun and it is. I usually
1748 find that I'm drenched with sweat, but I have a big smile on my face.
1749
1750

1751 Foot Position and Shift Lever / Brake Pedal Setup

1752
1753 How and where you place your feet on the pegs is almost as important as how you grip the bars. A pavement
1754 rider's feet are placed differently than an OR rider's feet. What works on the street doesn't work on the trail.
1755

1756 When seated on the bike, the usual placement of the foot on the peg is with the arch resting on the peg. That
1757 position allows the rider to press down with his right toe to use the rear brake, and press down or lift up with his left
1758 toes to change gears. Most beginner OR riders set up their shift and brake lever so they can comfortably use either
1759 control when seated. HOWEVER, this isn't the best setup to use when riding OR.
1760

1761 When you stand up on the pegs, your foot automatically rotates to a different angle than it does when you were
1762 seated. When you try to shift gears or use the rear brake you'll find them difficult to use... or suddenly you can't
1763 change gears or you can't find the brake pedal tab. There's nothing worse than needing that rear brake and
1764 pressing down with your right toe and hitting nothing but thin air. If you missed it, that's because you had it setup
1765 wrong, or your foot was in the wrong position.
1766

1767 I setup my foot controls so they fit me best when I'm in the standing position. I had to move both the shift lever and
1768 brake pedal. Even with those changes I can still use them effectively when seated. But if I hadn't made those
1769 changes then my OR riding abilities would be severely hampered.
1770

1771 I've added an extension to the brake pedal tab, so that I can always reach it with my right toe. I've adjusted my shift
1772 lever so I can easily fit my toe under the knob for an upshift. I usually have to lift my left foot off the peg a bit to get
1773 my toes over the top of the knob for a downshift. I'm used to it, and don't even think about it anymore.
1774

1775 When riding in a Standing **Neutral** position, I generally have the arch of my foot resting on the peg. My boots have
1776 steel arch supports in them so my weight is spread evenly on the bottom of my foot. Without that support my feet
1777 would quickly become painful.
1778

1779 When I assume the Standing **Alert!** or Standing **Charge!** Positions, I move my feet rearward slightly, so that the
1780 balls of my feet are resting on the pegs. This allows me to absorb bumps more effectively and puts me in a more
1781 agile position. Instead of standing "flat-footed" on the bike, I'm now "on my toes" and ready for anything. The
1782 distance I move my feet forward or rearward is really no more than about an inch, but that small distance makes a
1783 huge difference.
1784

1785 When I assume the Standing **Braking/Downhill** position, I again move my feet rearward slightly, so that the balls of
1786 my feet are on the rearward edge of the pegs. This prevents my feet from slipping forward, off the pegs. In order to
1787 use the rear brake I may have to slip my right foot forward.
1788

1789 When I have time I'll insert some photos showing the suggested placement of the feet on the pegs.
1790
1791
1792

1793 Turning the Bike When Riding Off Road

1794
1795 Pavement techniques call for "counter-steering". You push the bars forward on the right to turn right, push the bars
1796 forward on the left to turn left. It works great, but keep that technique where it belongs - on the pavement.
1797

1798 OR techniques are somewhat different because of the traction issues involved in the dirt. If you use a road riding
1799 technique that relies on counter-steering, you may experience some interesting events, none of which are pleasant.
1800 OR riding relies on different handlebar techniques, knee movements, weight transfer, and other "body English"
1801 techniques to control the direction of the motorcycle.

1802
1803
1804
1805
1806
1807
1808

When you're standing on the pegs you'll use your knees, your toes, the handlebars, and basically your entire body to control the direction of the motorcycle.

1. To turn right, press your left knee into the tank and at the same time press down on the right footpeg with your right toes. Push the handlebars bars to the right, in a lateral movement.

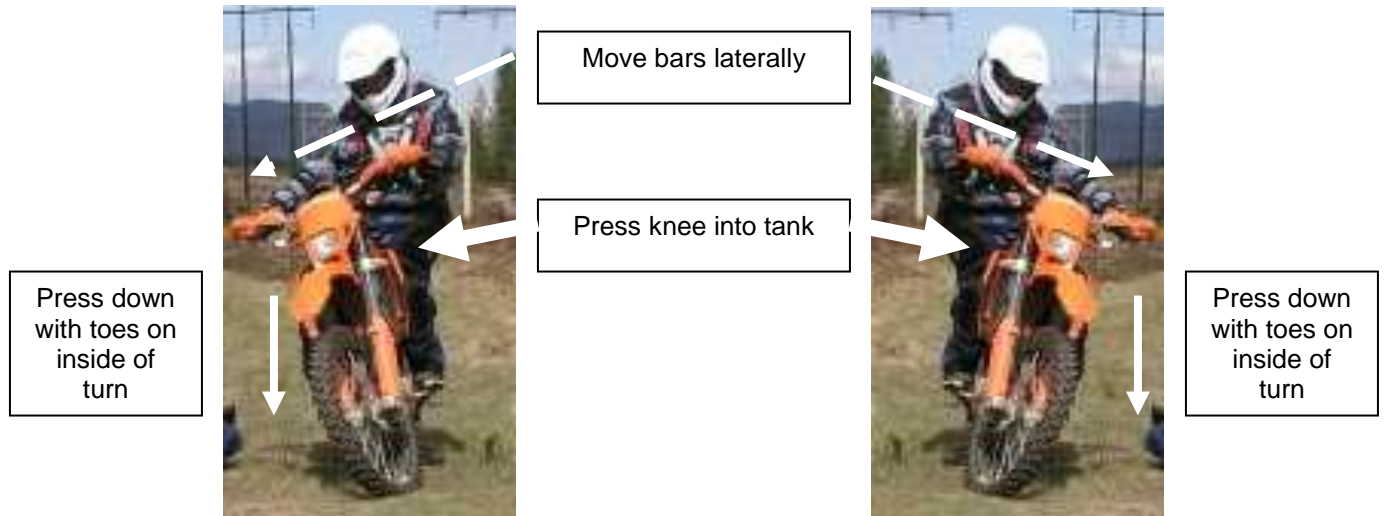

1809
1810
1811
1812
1813
1814
1815
1816
1817
1818
1819
1820
1821
1822
1823
1824
1825
1826
1827
1828
1829
1830
1831
1832
1833
1834
1835
1836
1837
1838
1839
1840

2. To turn left, press your right knee into the tank and at the same time press down on the left footpeg with your left toes. Push the handlebars bars to the left, in a lateral movement.
3. I don't intentionally TURN the handlebars right or left, instead I take the entire handlebar assembly and move it LATERALLY sideways in the direction of the turn, slightly pressing DOWN on the side of the bars closest to the inside of the turn.
4. The more you accentuate the above movements, the sharper the turn will be.
5. These techniques can be used at any speed when you're riding OR.
6. When practicing this technique in a slow figure-8 course, the rider will be making dramatic shifts of his body, from left to right and vice versa. He always stays "on top of the bike", keeping the bike between him and the ground.
7. Positioning your body "on top of the bike" keeps your center of balance over the contact patches of the wheels, which improves your traction.
8. Unlike a street rider who aggressively hangs off his bike on the INSIDE of the turn, the OR rider pushes the bike LATERALLY toward the inside of the turn, as he positions his body ON TOP of the bike (or away from the turn).
9. The key point to remember is that you want to be "pushing" the bike downward, toward the center axis of the turn. As you push the bike down you also move your body further away from the axis of the turn (away from the pivot point of the turn).

As described in the section on how to use your rear brake, you can also control your direction by skidding the rear wheel. Practice that technique at slow speeds, and gradually work up to about 10 mph. Above that speed things happen pretty quickly if you get your timing messed up.

1841 Learn slowly Grasshopper; wax-on-wax-off, like the Karate Kid. Practice the little things and master them
1842 thoroughly, before you progress to the more complex tasks.
1843

1844 **Throttle control**

1845
1846 Throttle control is even more important in dirt than it is on pavement. A bit too much throttle and you'll get unwanted
1847 wheel spin. Too little and you'll stall. Either extreme will set you up for a series of events that can cause a tumble,
1848 or at the very least it'll cause the Pucker Factor to spike.
1849

1850 It's a rare situation where you need to apply a full roll-on throttle like you do on the street. 99% of the time you'll be
1851 using subtle, gentle, and minute adjustments. Use the throttle sparingly. It can be your friend, but it can also bite
1852 the hand that feeds it.
1853

1854 Because a small throttle movement can cause large changes in the rotation of the rear wheel, you should also use
1855 the clutch to moderate (or cushion) the amount of power delivered to the rear wheel.
1856

1857 Rule of Thumb when it comes to the throttle – EASY DOES IT.
1858

1859 **Gripping the Bars – Applies to Both Hands**

1860
1861 New OR riders tend to clasp the handlebars in a white-knuckled death grip, as if that action will get them thru the
1862 dirt safely. A white-knuckled grip serves no purpose; instead it causes fatigue, it causes you to tense up, and it will
1863 literally cause you to fall.
1864

1865 Instead of gripping the bars tightly, grip them loosely and comfortably. You're going to be holding those bars for
1866 several hours, so hold them in a fashion that won't wear you out in the next 15 minutes.
1867

1868 Place your hands in front of you, flat on the table. RELAX. See the web of skin between your thumb and your
1869 index finger? You want to be able to see that web when your hands are holding the handlebars. You should also
1870 see an open space between the webs of your thumbs and the bars. If you don't see the open web, you're gripping
1871 the bars too tightly. Relax. Grip the bars firmly but Relax. Now RAISE your elbows. See how the web of skin
1872 between thumb and index finger moves away from the bars? You want to have a little space in there; it indicates
1873 that you're not over-gripping the bars.
1874



The proper way to do it – the bars are gripped firmly, elbows are up, and there's some space between the web of the hand and the bars.

1875
1876



While not technically “incorrect” or “wrong”, this grip will quickly lead to fatigue. The bars are gripped too tightly. There’s no gap between the bars and the web of the hand. You might need to use this grip for a really difficult section, but as quickly as possible return to an open-web grip.

1877
1878

1879 As you’re riding (on the street or in the dirt) if you begin to feel fatigue in your hands, arms or back, lift your elbows.
1880 That motion will cause your hands to relax and the tension you’re feeling in your arms will begin to diminish.

1881

1882 Whenever I’m riding thru some tough terrain, I make mental and visual checks of my hands. If I’m gripping the bars
1883 too tightly, I get tense and tired. When I raise my elbows and I look for the open web between thumb and index
1884 finger, I automatically relax.

1885

1886 There are certain situations where you might need to grip the bars with an extremely tight grip, for a few seconds
1887 only. Examples: you’re going over a log, you’re jumping over something, etc. In those cases grip the bars as hard
1888 as needed, but when you clear the obstacle immediately return to your relaxed open-web grip.

1889

1890 **Gripping the Bars – Right Hand – Brake Lever**

1891

1892 Street riding protocols (MSF courses) call for riders to hold the right grip with all 4 fingers until you need to you
1893 apply the brake, at which time all 4 fingers move to the brake lever. For OR riding MOST of the time you’ll be
1894 gripping the throttle with just your thumb and your ring and little finger. Your index and middle finger will be resting
1895 on the front brake lever.

1896

1897 This multi-function grip (both brake and throttle) can be a bit confusing for the Beginner. After time you’ll learn that
1898 you can roll the throttle on or off with the right side of your hand, while you control the brake with the left side of your
1899 hand.

1900



1901

1902
1903
1904
1905
1906
1907
1908
1909
1910
1911
1912
1913
1914
1915
1916
1917
1918
1919
1920
1921
1922
1923
1924
1925
1926
1927
1928
1929

Sit aboard the bike and practice this grip technique. It's a skill you MUST master if you're going to be comfortable when riding OR.

The main reason you only want to have 2 fingers on the front brake lever is that it prevents you from using too much front brake. Yes, it's possible to over-brake even with only 2 fingers, but the chances are lessened. Some riders use only 1 finger on the brake. Whether you use 1 or 2 depends on the situation and the ability of your front braking system to slow the bike. If you can do it with 1 finger, great. That leaves 3 other fingers to operate the throttle.

If your bike has an adjustable brake lever, move the lever in or out to accommodate your hand size. My hands are small so I usually need the lever in the closest position.

When making adjustments, make sure the lever doesn't touch the hand guard when it's in the forward position. If it does it can activate your brake light and/or cause premature brake wear (similar to riding the brakes all the time).

As mentioned in the section on setting up your bike, it's important that the lever be adjusted so you can easily operate the lever while standing on the pegs. If you have to bend your wrist in an unnatural position, then you need to adjust the lever. When you're standing on the pegs your arms should be fairly straight, your wrist should NOT be bent, and your index/middle finger should be along the same axis as your arm. There should be no noticeable cocking of the wrist or any unnatural bending of the fingers.

Gripping the Bars – Left Hand – Clutch Lever

As with the right hand, the left hand should be holding the bars loosely. Look for the open web between thumb and index finger. Ring and little finger wrap around the bars, while the index and middle finger should be resting on top of the clutch lever.



1930
1931
1932
1933
1934
1935
1936

With some bikes, once you get going you don't usually need to use the clutch anymore, so why leave 2 fingers on top of the clutch lever?

1. It keeps your hand in the open-web position

- 1937 2. It keeps you loose and comfortable
- 1938
- 1939 3. You're ready to use the clutch quickly
- 1940
- 1941 4. The clutch is used to control speed almost as much as the throttle, in certain situations
- 1942

1943 If your bike has an adjustable clutch lever, move the lever in or out to accommodate your hand size. My hands are
1944 small so I usually need to move the lever to the closest position.

1945
1946 Adjust the clutch engagement point so that the "slip point" of the clutch is just barely forward of the your little finger
1947 and ring finger, when they're gripping the bar. When you pull in the clutch, the transmission must be fully
1948 disengaged without you needing to open your hand. You shouldn't need to pull the clutch all the way back to the
1949 handgrip. Properly adjusted, the clutch lever should be disengaging the transmission just before the back side of
1950 the lever touches the top side of your fingers. In this next photo the rider's little finger and ring finger are still
1951 gripping the bars, the clutch is pulled, and it's making contact with the top side of his fingers.
1952



There's the ball at the end of the clutch lever. It's just touching the top of his ring ringer. This KTM lever is short and stubby – your bike's clutch lever may reach across both ring and little finger. Same principle applies.

1953
1954 Note that this photo shows a KTM motorcycle with special levers that have a dog-leg that are specifically designed
1955 for OR riding. Your bike may have longer, straighter levers but the principle is the same.
1956
1957

1958 When making adjustments, make sure the lever doesn't touch the hand guard when released. If it does it may
1959 cause your clutch to not fully release, or your brake light to be on all the time, or your front brake pads to wear
1960 prematurely.

1961
1962 As mentioned in the section on setting up your bike, it's important that the lever be adjusted or rotated on the bars
1963 so you can easily operate the lever while standing on the pegs. If you have to bend your wrist in an unnatural
1964 position then adjust the lever. As a rule of thumb when you're standing on the pegs your arms should be fairly
1965 straight, your wrist should not be bent, and your index/middle finger should be on the same axis as your arm.
1966

1967 1968 **Braking Techniques - Front brake**

1969 What you learned about using your front brake on the pavement is also true about using the front brake in the dirt...
1970 EXCEPT that the amount of pressure needed to lock up the front brake in the dirt is much, much, much less. Did I
1971 say "much less" strongly enough to make the point? Will you remember in an emergency? Probably not. That's
1972 why you limit your braking grip to 1 or 2 fingers on the lever. If you grab a handful of front brake in the dirt (with 4
1973 fingers), the wheel will lock and you'll kiss the ground before you can say OOPS. Been there, done that.
1974

1975
1976 Pretend there's an egg between the brake lever and the grip. Squeeze the brake gently but firmly, but don't break
1977 the egg.
1978

1979 You're saying to yourself, "If using the front brake runs the risk of locking the wheel, why not avoid using the front
1980 brake altogether?" Just as with pavement riding, most of your effective braking comes from the front brake. If you
1981 eliminate the front brake altogether, you've eliminated 80% of your braking ability. You've simply got to learn to use
1982 the front brake when riding OR, you just need to learn how to use it gently, firmly, and with discretion.
1983

1984 Advanced riders can actually lock the front brake and skid the tire without losing control, but that technique is
1985 beyond the scope of this Article. I will describe a front brake/front tire skidding drill in the field drills section.
1986

1987 As you apply front brake and the bike begins to slow, you'll want to gradually feather (ease) the brake as you come
1988 to a stop. If you don't the front wheel will suddenly lock up and at 2 MPH you'll fall down. This is very embarrassing
1989 when it happens in front of a group of fellow riders. Or so I'm told...its not like I'VE ever done it more than once.
1990

1991 1992 **Braking Techniques - Rear brake**

1993
1994 Rear braking techniques are quite a bit different than front brake techniques.

1995
1996 Consider the rear brake to be a boat anchor. You can throw it overboard and drag it along until it catches
1997 something firm and keeps the ship off the rocks. OK, that's a bit of a simplification, but you get my point.
1998

1999 Only 20% of the bike's braking ability comes from the rear wheel. That's bad, but the good news is that the rear
2000 wheel can be used to steer the bike almost as effectively as the handlebars.
2001

2002 Here's how it works:

2003
2004 1. As you apply rear brake the bike will gradually slow. Used by itself, the rear brake will eventually slow the
2005 bike, but you usually need some help from the front brake to get the job done effectively, in the shortest
2006 distance.

2007
2008 2. As you apply more pressure to the rear brake pedal, the weight of the bike will shift forward. The rear
2009 suspension will unload, and the rear of the bike will tend to rise. The rear wheel may actually lock up and
2010 the wheel will stop spinning. NO PROBLEM. Don't panic. Yet.
2011

- 2012
2013
2014
2015
2016
2017
2018
2019
2020
2021
2022
2023
2024
2025
2026
2027
2028
2029
2030
2031
2032
2033
2034
2035
2036
2037
2038
2039
2040
2041
3. If you're braking in a straight line, on level ground, you can easily skid to a complete stop with the rear wheel locked. Skidding the rear wheel can be a bit of fun, so practice it occasionally.
 4. If the bike starts to veer slightly one way or another, turn the bars gently into the turn and correct as needed.
 5. As you brake shift your weight to the rear, intentionally placing your butt as far back over the rear wheel as you can. This greatly improves your bikes braking ability.
 6. If the bike starts to veer in a direction you don't want it to go, and your steering corrections aren't working, GENTLY release the brake lever until the bike goes in the intended direction, then gently reapply the brake
 7. If you suddenly release the brake lever all the way, the bike will regain traction in an instant, then it will make a sudden upright movement and you'll "high-side", or....
 8. The bike will take off in the direction it was pointed when you released the rear brake.
 9. This sudden change of direction can work to your advantage (if you're ready for it). I call this "skid steering"
 10. If you apply throttle at the moment you release the rear brake, the bike will head off in a new direction and you won't have to turn the bike using the handlebars.
 11. This technique works best (for me) when I'm making a left turn, because I tend to want to dab the ground with my left foot at the point of transition. Some call this dab a sign of timidity – I call it prudence.
 12. For right hand turns it's harder to do because my right foot is on the brake pedal. I can't dab my foot because I'd have to remove my foot from the brake pedal.

Braking Techniques – Bike Position, Body Position

2042
2043
2044
2045

When riding on the pavement you can easily can apply brakes even if the bike is leaned into a turn.

2046
2047
2048

Try that in the dirt and the bike will usually kiss the ground. Experts can get away with it – but you shouldn't try it if you're a novice. If you really need to brake when the bike is leaned over, you should do it VERY gently.

2049
2050
2051

When riding OR it's important that the bike be in a relatively upright position whenever you apply the brakes. This prevents the tires from "washing out" or suddenly losing traction because you over-braked.

2052
2053
2054

Shift your weight to the rear whenever you brake – extend your arms and move your butt over the rear wheel to maintain traction and to counteract the front end dive that comes with braking.

2055
2056
2057
2058

Use 2 fingers on front brake, apply rear brake with right foot, get ready to pull in the clutch, shift down as needed, and come to a stop. You should be in 1st gear when you stop. In a panic situation you might forget to shift down, but that downshifting technique will develop over time.

2059
2060
2061
2062

What do you do if you can't get the bike upright and braking is necessary? I try to push the bike into an upright position as much as I can, and at the same time I move my body to compensate for the bike's position. Here's how it works (left hand turn described – a right turn is the same, only reversed):

- 2063
2064
2065
2066
2067
1. I'm in a left turn on dirt or gravel and I see an obstacle in my path.
 2. I CAN'T straighten the bike or choose an alternative path, before I hit the obstacle.
 3. I push the bike to the right so it assumes as much of an upright position as possible.

2068
2069
2070
2071
2072
2073
2074
2075
2076
2077
2078
2079
2080
2081
2082
2083
2084
2085
2086

4. To compensate for this movement, I move my body to the left (between the bike and the ground.)
5. This results in the bike moving into a more upright position, perpendicular to the ground
6. I apply as much braking as possible, without running the risk of locking the wheels.
7. As the bike slows, I can move my body back to the centerline.
8. This balancing technique isn't done just by moving the handlebars, instead it's done by moving my body off the centerline of the bike, into the apex of the turn.
9. This technique is **NOT** to be confused with the normal braking techniques that are used in the dirt.

This is what it looks like: If the guy on the left applied his brakes with the bike at an angle, he might lose traction and fall down, but he still has to miss the obstacle. So.... He moves his body inward toward the obstacle, and PUSHES the bike upright. Now he can apply his brakes with less chance of locking the wheels. Of course he still has to miss the obstacle with his body, so he's going to have to shift his position again.

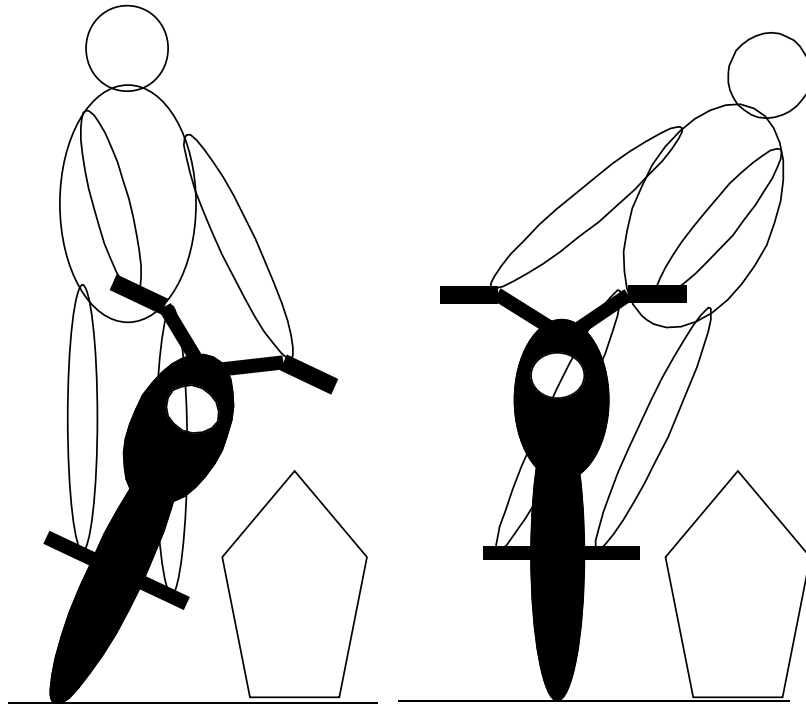

2087
2088
2089
2090
2091
2092
2093
2094
2095
2096
2097
2098
2099
2100
2101

Using the Clutch

As mentioned earlier, once you get the bike rolling the clutch may not be needed, especially if you have a wet-clutch system - no clutch is needed for shifting. If you have a dry-clutch system like the BMW R12GS, you'll need to use the clutch every time you shift (yes you can shift without the clutch if you're careful to match wheel speed and engine speed, but it's harder).

Regardless of whether you need the clutch to shift, you'll need to learn to use it effectively if you're riding OR. The clutch is used to control your speed, it's used to control traction, and it's used to help you get moving whether you're starting out on the level or starting out on steep a grade. You need to learn the "sweet spot" on your clutch, and you need to learn to play it like it's a piano or a guitar, with finesse.

2102
2103
2104
2105
2106
2107
2108
2109

Adjust your clutch lever (and clutch cable) so you can grip the handlebar with your thumb and little and ring finger, while holding the clutch at the slip-point / release-point with your index and middle finger. If your clutch doesn't engage with your hand in that position, you need to make the necessary adjustments. If your clutch doesn't engage until you fully release the lever, you need to make adjustments. This photo shows the ball at the end of the clutch lever, pressing up against the rider's ring finger. The clutch is fully engaged, no power going to the rear wheel from the transmission. The rider didn't have to open up his hand to get full clutch action.

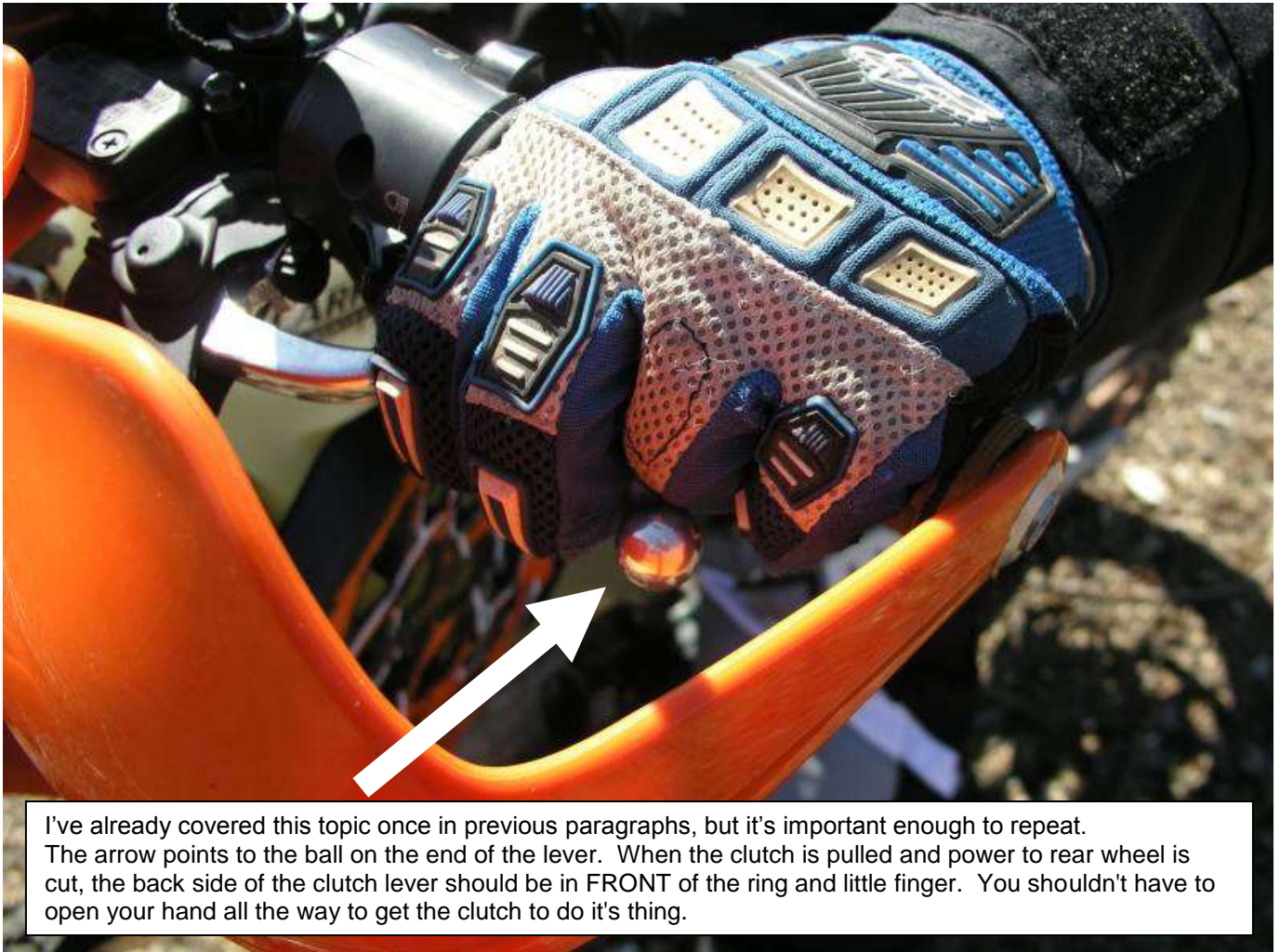

I've already covered this topic once in previous paragraphs, but it's important enough to repeat. The arrow points to the ball on the end of the lever. When the clutch is pulled and power to rear wheel is cut, the back side of the clutch lever should be in FRONT of the ring and little finger. You shouldn't have to open your hand all the way to get the clutch to do it's thing.

2110
2111
2112
2113
2114
2115
2116
2117
2118
2119
2120
2121
2122
2123

You need to be able to firmly hold the bars with the outside of your left hand, while you feather the clutch with the inside of your left hand (index and middle finger). The clutch lever should touch the inside of your fingers at the first joint, or closer. If you can't get the clutch lever inward far enough to get it past that first finger joint, make adjustments. You have no strength at the very tips of your fingers, but you do have strength once the lever is behind the first joint or knuckle.

When the clutch is fully engaged (no power to the rear wheel), you shouldn't have to open your hand, or move your ring or little finger, or remove them from the handgrip in order to get the clutch to engage. When engaged (clutch lever pulled), the backside of the clutch lever can be touching the tops of your little and ring finger, which are wrapped around the handgrip.

2124 **Shifting Gears**

2125

2126 Shifting gears should be done smoothly, without popping the clutch or jerking the bike and rider. Yeah, popping the
2127 clutch and lifting the wheel looks cool, but for most riders it's an invitation for a loss of control. Popping the clutch is
2128 only suitable when going over an obstacle (that technique is covered later).

2129

2130 Anticipate the trail ahead. Do you need to shift down in order to go thru that puddle? Is the trail ahead smooth and
2131 safe, which invites a higher gear and faster speeds? You'll need to decide. The act of riding a motorcycle requires
2132 constant analysis of the conditions, decisions on how to handle the situations, and immediate actions to carry out
2133 those decisions.

2134

2135 Many riders wonder which gear they should use in a given situation. 1st? 2nd? 3rd? The variables are too large to
2136 provide you with any hard and fast rule. You'll need to consider the power of the bike, the grade of the slope, etc.
2137 You want a gear that will deliver enough power to the rear wheel, without over-revving, and without bogging down
2138 and killing the engine.

2139

2140 Up-shifting quickly is seldom needed, but down-shifting quickly is a pretty common occurrence. Even a BMW with a
2141 dry clutch will allow you to roll off the throttle and drop down a gear without the clutch. Dropping the gear allows
2142 you to bring up your RPM and delivers more power to the ground. This is often needed when climbing hills – you
2143 started up in 2nd gear, but the engine begins to bog down so you stab into 1st gear and complete the ascent. If you
2144 have time to use your clutch, that's great. If you don't have time there's going to be a bit of gear grinding as you
2145 drop down a gear, but at least you'll make it to the top of the hill.

2146

2147

2148 **What To Do When You Fall**

2149

2150 It's inevitable - you're going to fall down if you ride OR. When that happens not all is lost. Don't give up. It's not the
2151 end of the world. This next photo shows me in one of my Senior Moments. I dropped my bike and Steve's coming
2152 over to help. I could hear him laughing in his helmet. When I asked him about it, he told me he was "coughing".
2153 Yeah, right. My chance to laugh at Steve would come a few miles later.

2154



2155

2156

2157 Use proper techniques to lift the bike. Don't use your upper body – you'll only hurt yourself. Visit these sites to see
2158 how you can lift a heavy bike by yourself. You can Google "how to lift a fallen motorcycle) to get other techniques.
2159 These two sites show how to lift on level ground. Sometimes we don't have that luxury when riding OR.

2160

2161
2162
2163
2164
2165
2166
2167
2168
2169
2170
2171
2172
2173
2174
2175
2176
2177
2178
2179
2180
2181
2182
2183
2184
2185
2186
2187
2188

<http://www.pinkribbonrides.com/dropped.html>

<http://team-oregon.org/resources/lifting/>

When the bike's gone down, here's the things you need to do BEFORE you try to get the bike back up:

1. Assess the situation - don't panic. Slow, deep breaths. As an Aussie friend says about falling down, "She'll be right, mate. Take a spoon of concrete, and settle down." He meant that I should toughen up and remain calm.
2. Protect yourself from further injury. Get off the trail or road. Don't worry about the bike – worry about YOU.
3. Perform 1st aid as needed. That means you'll need to get to your 1st aid kit quickly. Don't pack it in the bottom of your saddlebag where you can't get to it.
4. Don't try to get the bike upright (immediately). It'll be fine where it is. Instead, take a few moments to plan your next move, taking into account all the circumstances.
5. Turn off the ignition. Or at least hit the kill button if the engine is running.
6. If the bike is leaking gas, try to spin it around so that the fuel leakage stops. If it has fuel petcocks, turn them off if you can reach them.
7. Rest for a few minutes, eat a snack, drink some water, consider your situation, and then make a plan.

This next rider's had a bit of a tumble. He's OK. He's doing the right thing by taking a few minutes to rest, regroup, and rehydrate before taking the next step – recovery of the motorcycle. There's no hurry.



2189
2190
2191
2192
2193
2194
2195

I've been in situations where I waited 30 minutes before I tried to get the bike upright. I took photos, had a bite to eat, and drank some water. I also waited for my buddy to come along so he could help. When he didn't, I had to lift the bike by myself. It's not EASY, but it's certainly possible for me to do by myself, and if I can do it then you can do it too. Here's how:

- 2196
2197
2198
2199
2200
2201
2202
2203
2204
2205
2206
2207
2208
2209
2210
2211
2212
2213
2214
2215
2216
2217
2218
2219
2220
2221
2222
2223
2224
2225
2226
2227
2228
2229
2230
2231
2232
2233
2234
2235
2236
2237
2238
2239
2240
2241
2242
2243
2244
2245
2246
2247
2248
2249
2250
2251
1. Remove any extra gear from the bike to lighten the load. Take off duffels, tank bags, etc. You might even consider removing saddlebags if they have quick release mounts.
 2. Lifting on pavement is easier than in the dirt, but the principles remain the same. Use your legs, not your upper body. Most riders hurt themselves when they try to lift the bike using upper body strength. The proper lifting technique uses very little upper body strength – instead it relies on the muscles in your legs and buttocks.
 3. If you're on a slope, spin the bike around so the wheels are lower than the gas tank and saddle. This minimizes the distance you'll need to lift the bike. Lifting the bike when the wheels are higher than the gas tank is still possible, but it's much harder work.
 4. If possible, turn the bars so the front wheel is pointed down to the ground. This puts the handlebar grip in a position where you can use it as a lifting point.
 5. If the bike is down on the RIGHT side, extend the sidestand. If the bike is down on the LEFT side don't worry about the sidestand.
 6. Use a strap or zipties or some tape to temporarily clamp the front brake, so the front wheel is locked. This makes it easier to get the bike back up because the front end won't try to roll away from you as you lift.
 7. On the ground clear away any loose gravel, slippery leaves, etc. In the field this isn't always possible, but do the best you can.
 8. Put your backside up against the seat. Face away from the bike.
 9. Plant both feet solidly on firm ground, about 24" away from the bike.
 10. Squat down, bending at the knees, and put your butt on the edge of the seat
 11. Keep your back straight, with a slight arch in it. Keep your head up, and look at the horizon. This keeps your posture in the correct position and keeps you from hurting your back.
 12. Grab the handlebars with one hand, and the underside of the seat or a convenient frame rail with the other hand.
 13. Take up "slack" between your body and the bike. Push your butt firmly into the saddle.
 14. Begin walking backwards, taking small steps of about 2-3", one small step at a time.
 15. As you begin to walk backwards, your goal is to lift the bike with the power of your legs, NOT your arms or upper body. This technique is the equivalent of a hip/leg squat; this is NOT an upper body bench press.
 16. As you walk backwards the bike will rise upright, very slowly but very surely.
 17. As you approach the point where the bike is nearly upright, slow down your backwards walk. You don't want to push the bike too far or it'll fall over on the other side. Been there, done that, looked like a fool, had to lift the bike again from the other side.
 18. If the bike was on the right side, and you deployed the sidestand, the chances that the bike will fall over on the other side are minimized.
 19. If the bike was down on the left side you won't have the luxury of deploying the sidestand. You have to stop lifting the bike before it gets fully upright; if you don't stop soon enough you run the risk of pushing the bike over too far.

2252 20. Regardless of which side the bike is lying on, once you get the bike up to a balance point, slowly turn
2253 forward and put both hands on the grips and establish control of the bike. As you make that turn, carry the
2254 weight of the bike against your hips.
2255

2256 Practice these lifting techniques when the bike is unloaded. Then do it fully loaded. You'll be surprised how
2257 easy it is when you do it the CORRECT way. You'll be surprised how difficult it is if you do it the WRONG way.
2258

2259 Once the bike is upright, check for damage. Do a complete walk-around, assessing all the components
2260 including lights, signals, switches, levers, etc. Make repairs as needed.
2261

2262 Don't let a tumble or a fall discourage you. Consider it as part of the experience. Laugh about it, even if you
2263 have to do it thru clenched teeth. Like I said before, falling down is not the end of the world.
2264

2265 When you're satisfied that it's safe for you to continue, mount the bike, turn ON the gas, turn ON the kill switch,
2266 turn ON the ignition, RETRACT the sidestand. Forget any of those items and the bike won't start. I've forgotten
2267 all of those little details, at one time or another, and spent several minutes dull-wittedly trying to identify the
2268 problem before I could get the bike to start. The Fall-Down was bad enough; the Idiot Beacon that came on
2269 (because I forgot those few simple things) made the incident even more memorable.
2270
2271

2272 **Climbing a Hill**

2273
2274 The world's not flat. If you ride Off Road you're going to have to climb up something, or go down something.
2275 Neither one's really that hard; they just require that you have an understanding of the techniques. You'll need some
2276 positive encouragement and some practice to become proficient.
2277

2278 When climbing a hill you need to
2279 consider the length of the ascent, the
2280 grade, the road or trail conditions, and
2281 whether your bike has the power to
2282 make the climb. You'll also need to ask
2283 yourself if you really want to climb that
2284 hill in the first place. If the answer is
2285 YES, then set your mind to it and make
2286 it happen. Don't be tentative about your
2287 delivery – throw all your chips on the
2288 table and “go all in”. He who hesitates
2289 (on a hill) is lost.
2290

2291 That's a loooong hill in the photo and
2292 the perspective doesn't do justice to the
2293 grade. It was bloody steep. Could I
2294 have made it up safely? Yes, I could.
2295 Did I need to climb the hill? No. It
2296 wasn't worth the risk. There was
2297 another 500 miles of riding ahead of
2298 me. Next time I'm on the CDR I'll unload
2299 some gear and climb to the top, just so I can cross that hill off my list.
2300

2301 When you're first learning to climb a hill you shouldn't start out on the Widow Maker. Begin with small gentle hills
2302 that keep your risk levels low. You need to practice the basics and you need to be encouraged by having success,
2303 not discouraged by having failure.
2304

2305 Climbing a hill isn't all about speed or momentum, although those factors certainly play into the equation. Instead
2306 it's all about traction. You don't need a bunch of wheel spin to climb up a hill. The most effective ascent is done
2307 with zero wheel spin. No spin means you selected the proper gear and you used your clutch and throttle effectively.



2308
2309
2310
2311
2312
2313
2314

As you select your path up a hill consider any obstacles along the way. Avoid loose patches, large rocks, or things that will upset your balance. Smooth bare soil might be best, wet grass or pine needles might be worst. On this hill there's a few challenges... the right track has a large rock near the top, which would cause the front end to pop up and the rear tire to break traction. The center has loose grass and clumps of dirt. The left has the best path, even though there's a lot of loose round rocks in the tire track.

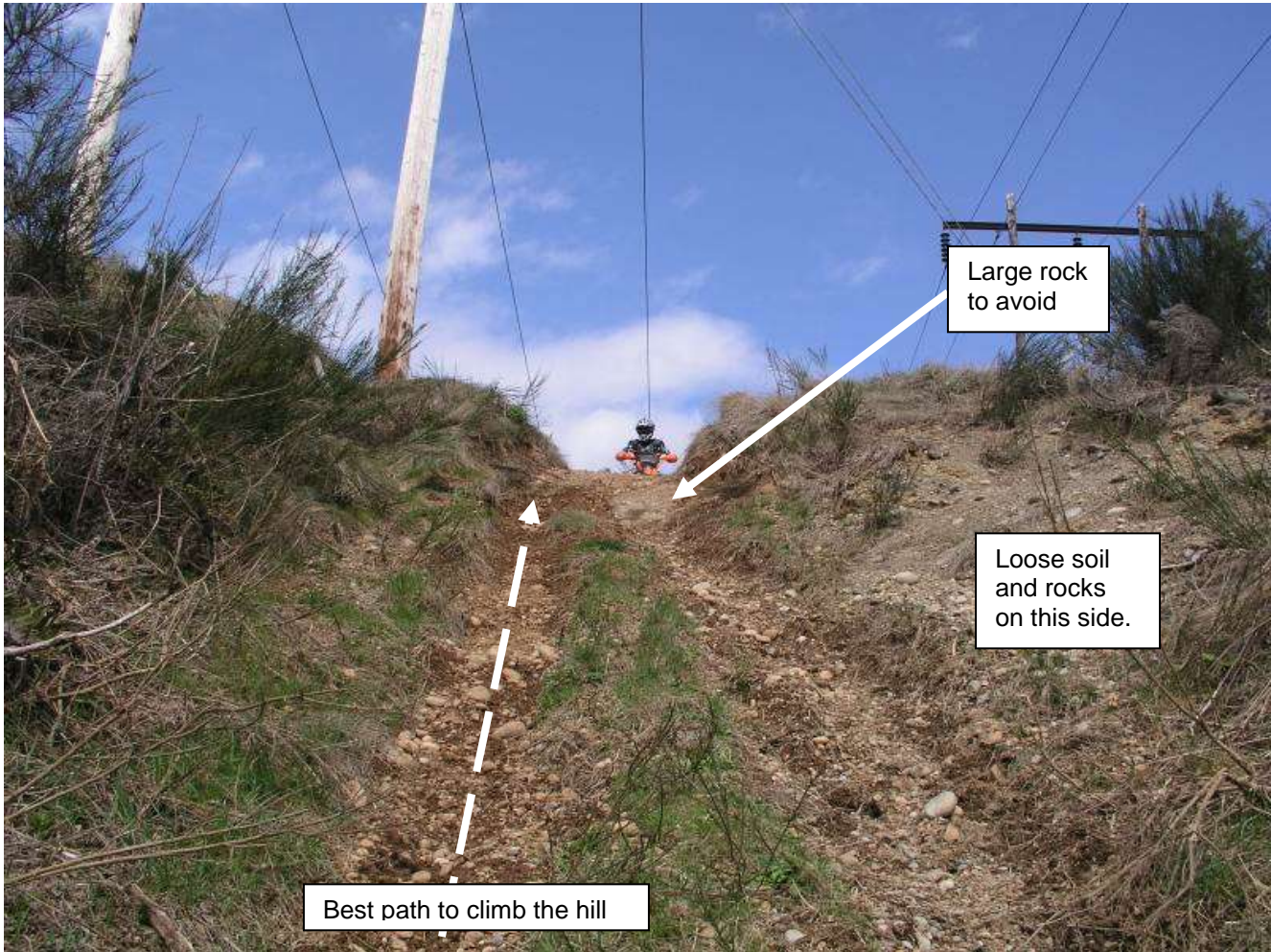

2315
2316
2317
2318
2319
2320
2321
2322
2323
2324
2325
2326
2327
2328

As you climb the hill keep your weight to the front – assume the **Charge!** position and keep your head over the bars. This prevents the front from lofting. Move your body forward and backwards slightly to control traction and wheel spin.

In this next photo I'm showing good form (for a change). I'd like to be forward even more, but somebody put a fat belly in my way and it's already touching the handlebars. My knees are slightly bent to absorb the bumps on the hill. I'm using my clutch to moderate power to the rear wheel, and I'm also controlling wheel spin by moving my body forward or backwards slightly.

Even though I'm riding my KTM for these photos, the techniques would be the same if I was on my BMW F800GS or the R1200GS. I've actually ridden both of those bikes on these same trails, and I've climbed and descended this same hill on both those big bikes. I was alone at the time so nobody was there to take photos.



2329
2330



2331
2332

2333 Slip your clutch as needed to maintain sufficient RPM, but don't over-rev or create a huge rooster-tail off the rear
2334 tire. A spinning rear wheel indicates that your bike's horsepower isn't being used effectively. In the above photo
2335 you can see a small amount of dirt spray from the rear wheel.

2336
2337 If the hill is so steep and so long that you decide to start up in 2nd gear so you can carry some momentum, be ready
2338 for a quick stab to the shift lever so you can drop into 1st. At the point where you make the shift there's going to be
2339 a moment when power's not being transmitted to the ground, so the bike will hesitate. Don't let that slight hesitation
2340 throw you off balance, or forward over the bars.

2341
2342 Stay on the pegs, stay in the **Charge!** position. If your feet leave the pegs or your butt hits the seat, or if you start
2343 dog-paddling up the hill, you've probably lost the battle. Time to regroup. See the next section about what to do
2344 when you get stuck on a hill.

2345
2346 As you approach the summit of the hill, roll off the throttle. If you don't, the bike may go airborne and/or you may go
2347 over backwards. Let your momentum carry you up and over the summit with just enough speed that you can come
2348 to a gentle stop if desired. Remember, you're on a large dual-purpose bike. Now's not the time for X-Games
2349 antics. You're not being graded on your landing after a 3-foot off the ground airborne episode.

2350
2351

2352 **Getting Stuck On a Hill**

2353
2354 If you're climbing the hill and you hit an obstacle that throws you off balance, or you realize you've bitten off more
2355 than you can chew, the best bet is to shut things down right then and there. End it quickly. Don't try to ride out the
2356 event or stay on the bull at the rodeo. Once you start to lose control, and certainly once you've fully lost control,
2357 most attempts at recovery usually result in a tumble.

2358
2359 Method 1 – Sweeping U Turn. To terminate an ascent, pull in the clutch, apply brakes if needed, keep the bike
2360 pointed uphill, put down your left foot, then lean the bike over toward the left side. (or the right side depending on
2361 the situation). If the slope's not so steep that the bike starts to roll backwards even with both brakes applied, then
2362 you can probably keep the bike upright. If the slope's really steep, just lay the bike over on the left side and step off.
2363 Gather your composure. Take a breather. Enjoy the view. Pretend that you actually WANTED to stop on the hill
2364 so you could take pictures. Like the cat that falls off the ironing board, make people think you intended to stop.

2365
2366 When you're ready to descend, wiggle the bars so the front end rolls around to the right and moves downhill. You
2367 can release the brakes slightly so the front end moves easily. You're going to be making a big clockwise rotation
2368 with the front of the bike, keeping the rear wheel in one spot, and allowing the front wheel to roll around in a
2369 downhill arc. Think of this as pivoting the bike using the left footpeg and/or pivoting on your left foot. Once the front
2370 end has rotated so that the bike is perpendicular to the slope of the hill, climb on, push off, and ride down the hill.

2371
2372 In these photos my riding buddy Scott demonstrates how to turn around on a hill. He stabilizes the bike using the
2373 handlebars and seat. The bike is in gear, engine off. He uses the clutch to control rear wheel movement and
2374 braking. This hill is so steep Scott can't reach the right side front brake lever. It's at least a 45 degree slope.

2375
2376 Scott stabilizes the bike and steps off to the left. The bike is in gear, engine off. He supports the bike with 2 hands.
2377 If the terrain was more favorable he would step in and hold the bike up with his hip, but due to the ruts that simply
2378 wasn't possible.



2379
2380
2381

Scott gets the bike turned sideways to the slope, then he climbs aboard.



2382
2383
2384
2385
2386
2387

To get the front wheel further down the slope, Scott wiggled the bars back and forth, left and right. That motion caused the wheel to skitter downhill. He climbed aboard, turned switches ON, started the bike, pointed the front wheel downhill, and pushed off with his left foot. Away he went, smooth as silk. Easy peasy. Well, sort of.



2388

2389
2390
2391
2392
2393
2394
2395
2396
2397
2398
2399
2400
2401
2402
2403
2404
2405
2406
2407
2408
2409
2410
2411
2412
2413
2414
2415
2416
2417
2418
2419
2420
2421
2422
2423
2424
2425
2426
2427
2428
2429
2430
2431
2432
2433
2434
2435
2436
2437
2438
2439
2440
2441
2442
2443
2444

Method 2 – Ride Down Backwards. When you can't do a sweeping turn-around as described above, an alternative method of stopping on a hill and going back down, is to "ride down backwards". Hmm... sounds dangerous, but it's really not, if you do it properly and the hill's not too steep.

This method should not be used on extremely steep hills. What exactly does that mean? Don't use it on slopes where the bike would have difficulty staying upright or stationary, with both wheels locked. If slope is so steep that the bike starts skittering downhill in spite of both wheels being locked up, then don't use this method.

As you're going up the hill and decide you're had enough, keep the front wheel pointed uphill and let the bike "gently" stall on the slope. That means you roll off the throttle and let the engine die. Leave the clutch lever out (don't pull in the clutch). Put down your left foot, apply the front brake, and use your right foot to apply the rear brake. You can probably keep the bike upright using only your left leg. Both wheels are locked. Even if you remove your right foot from the brake the rear wheel will probably remain locked because the engine is dead, and because you're in 1st gear.

To go backwards down the hill, put both feet on the ground to act as stabilizers. Lean forward as far as possible. Keep the front wheel pointed straight uphill. Gently squeeze the clutch lever, allowing the rear wheel to roll backwards slightly. Gently release the front brake lever, allowing the front wheel to roll backwards slightly. As you roll backwards, use your legs to keep the bike upright. Adjust steering as needed. Feather the clutch and the front brake to control your rearward speed.

When using this technique, you need to be careful that you don't build up a "head of steam". Keep your downhill speed low, nothing more than a crawl. If you don't then things will happen very quickly. If you find that you're going faster than expected, just lay the bike down on one side.

You don't need to go ALL the way down the hill backwards. When you get to a safe spot, turn the bars enough so that the bike sweeps left or right, and comes to a stop perpendicular to the slope. Start your engine, turn your bars downhill, give the rear wheel some power, push away from the slope, and ride down the hill.

I know these techniques sound easy on paper, but can be surprisingly difficult in the real world. Take comfort in knowing that both methods work, regardless of the slope. It takes some practice, so find a gentle hill and practice a few failed ascents. You'll be glad you did.

Going Down A Steep Hill

A steep downhill brings fear to the heart of many, many riders. Steep downhills conjure up visions of a fiery death at some point during the descent, and that fate is certainly waiting for them at the bottom. When you're at the top looking down you'll probably say to yourself, "Couldn't I just stay on level surfaces? Why do I need to go down the hill anyhow? Why can't everything be flat and smooth? I feel a headache coming on..."

The good thing about a downhill slope is that once started, it always results in one thing: your bike will somehow get to the bottom of the hill. The condition of the bike (and of you) at the bottom is what you're going to learn to control.

Select a downhill track that avoids rocks, loose obstacles, slippery grass or other obvious hazards. Select a course that has a good "run-out" path, meaning that there's a nice runaway ramp waiting for you at the bottom of the hill. At the bottom you don't necessarily need to come to a complete stop – you can still be carrying some speed, within reason of course.



2445

2446 Here's that same hill where Scott demonstrated
2447 how to turn around when stuck on a hill.

2448

2449 As you start the descent your engine is running
2450 and you're in 1st gear, unless you anticipate that
2451 your run-out path will be at a speed higher than 1st
2452 gear will handle.

2453

2454 Descent speed is controlled with your brakes.
2455 Most of the braking effectiveness comes from the
2456 front brake. Use 2 fingers on the lever.

2457

2458 Descent speed is also controlled by the clutch.
2459 Use it to control rear wheel rotation, which uses
2460 engine compression to assist with braking.
2461 Slipping the clutch causes the rear wheel to be
2462 slowed, almost as effectively as using the rear
2463 brake pedal.
2464

2465

2466 Proper downhill riding position is the same that you use when **Braking** – your arms are straight (not locked) and
2467 your butt is as far back as you can manage. Your feet are on the pegs, and your butt is off the saddle. That means
2468 you're not actually sitting down. Your butt might be touching the rear luggage rack but you're NOT sitting on it.

2469

2470 In these next photos if my arms were longer, my butt would be even further back. And if my legs were longer
2471 there'd be more space between my butt and the rack. Because they're not, I've learned to work with what I've got.
2472 If you're given nothing but lemons by the Good Lord, you need to learn how to make lemonade.

2473



2473

2474
2475
2476
2477
2478

I enjoy going down steep hills. It gives me a chance to practice my braking techniques. I play a game to see how slowly I can descend, and I'll even come to a full stop for a few seconds partway down, and balance the bike without putting down a foot, then I'll descend a bit further and repeat the process. That drill sharpens my skills.



2479
2480
2481
2482
2483
2484
2485
2486
2487
2488
2489
2490
2491
2492
2493
2494
2495
2496

Because your weight is going to be kept over the rear wheel there's more braking power available to the rear wheel than in most other situations, but the majority of your braking performance still comes from the front wheel. On this hill I was only using 1 finger on the front brake lever, and that still gave me all the braking I needed.

On every descent keep your engine running, even if the clutch is pulled in. Don't let the engine stall.

Start your descent slowly, feeling out the terrain with your tires. If you sense trouble, turn to the left, apply heavy rear brake and lay the bike down its the side. Regroup, plan, and then execute your next step.

I've been down some really atrocious slopes – ones that were a challenge to walk down on foot, much less descend on 2 wheels. Nevertheless I rode down them by using proper brake control and I didn't allow the wheels to lock up. You **MUST** allow the wheels to rotate. If they stop rotating then you'll begin skidding and you'll lose your ability to control your direction or retard your descent.

If you find your front wheel or rear is locking up, release that brake slightly until the wheel rotates. Then gently reapply brakes. It only takes a fraction of a second for the wheel to begin rotating again.

2497

2498 During that short time when you regained rotation the bike will have picked up a bit of downhill speed. No worries,
2499 don't panic. Gently brake again until you regain control and your speed is checked.

2500

2501 What about the horribly steep downhill that takes ahold of both rider and bike and draws them faster and faster, to
2502 their eventual doom? I've actually ridden down that very same hill, safely. It wasn't fun at the time but I still made it
2503 to the bottom. Looking back I see that I made a couple mistakes, including the one where I let the rear wheel lock
2504 up. As soon as I regained rotation I was able to re-establish control. Yes, my hands were shaking and my stomach
2505 had butterflies but I lived to tell the tale.

2506

2507 OK, how about a worst case scenario, like you're trying to descend the north face of Everest and the bike seems to
2508 be going faster and faster in spite of your best efforts:

2509

- 2510 1. Lock up the rear wheel with right foot, step off the bike to the left side, let the bike come to a rest
- 2511 2. If you can't step off, roll off either side or off the back, but somehow get off the bike.
- 2512 3. The idea is to let the bike slide downhill on one side, not roll down on its wheels or tumble end over end
- 2513 4. If the slope is too steep for a safe descent, use the Motorcycle Recovery System to get the bike down
2514 <http://www.bestrestproducts.com/c-168-recovery-gear-mrs.aspx>
- 2515 5. Have your buddies stand on the downhill slope, acting as safety catchers – they won't be able to stop a bike
2516 that's already built up a head of steam, but they can help you in the first few seconds of an emergency
2517 descent.

2522

2523 Descending hills requires practice. Find a gentle slope and ride halfway down. Come to a controlled stop on the
2524 hill. You want to practice going down the hill as slowly as possible. Once stopped, creep ahead few inches before
2525 you stop again. Put your left foot down to keep the bike upright, but keep your right foot on the brake. Identify the
2526 braking point for front and rear tire, allowing them to rotate slightly. Get comfortable doing it.

2527

2528 You'd be surprised at how steep a slope you can go down safely. At the Ride Coach! Training Center I came down
2529 a slope that I swear to this day was humanly impossible. But I did it while fully under control and without any risk or
2530 danger. My speed never got above a snail's pace, but that's what was needed to maintain control.

2531

2532

2533 **Look Where You Want The Bike To Go**

2534

2535 Look where you want the bike to go – don't look at the obstacle ahead, or at the drop-off, or at the rut, or at the
2536 patch of gravel, or at the puddle. If you focus on the obstacle, you're going to hit it, or ride over it, or ride off it.
2537 Keep your eyes on your objective. Keep your eyes on the ball. Focus on your intended path, ignore everything
2538 else.

2539

2540 Think of it this way: If you WANT to go over the embankment all you have to do is keep LOOKING at it. Sure as
2541 shootin' that's where you'll end up. If you WANT to follow the trail that skirts the edge of that embankment, LOOK
2542 AT THE TRAIL. Ignore the drop-off.

2543

2544 I ride some pretty challenging trails down by Mount St. Helens on my KTM 450. They're single-track trails that
2545 narrow to about 6" wide in places. On the uphill side of the trail the slope is so steep that my handlebar is swishing
2546 against the hill. On the downhill side... well let's just say it's bloody steep and the descent would be unpleasant. At
2547 least I'd have time to think about my family and the things I'd accomplished in my life while I was on my way down.
2548 How do I ride those trails? It's possible because I'm consciously looking ONLY where I intend to go. Because I
2549 focus only on where I want to go, that's where the bike goes.

2550

2551 Remember Forest Gump and the ping-pong ball? He kept his eyes on that little white ball, no matter what else was
2552 going on around him. Your goal is to keep your eyes on the ball – only your ball is the trail that lies ahead.

2553

2554

You need to keep your eyes on your objective, not on the obstacles you're facing. Example: You come around a corner and there's a large rock in the road. First you have to identify the hazard, then you instantly identify a safe path around that hazard. Keep looking at your intended path and you'll avoid that rock. But if you focus on the rock you're going to punch it, I guarantee it.

2555

2556

2557

2558

2559

Anti-Lock Breaking Systems (ABS)

2560

2561

ABS was developed for pavement riding. A computer senses wheel rotation. If you over-brake and the wheel stops spinning the system releases the brake for a few milliseconds so the wheel can resume rotation. It's a good system for the pavement but not so good for dirt riding.

2562

2563

2564

2565

Although it's possible to ride OR with your ABS engaged, it's not generally a good idea. Some may argue that ABS is still a viable tool when riding in the dirt, but from my experience it's a HUGE handicap. I strongly recommend that you disengage your ABS system whenever you leave the pavement. Each manufacturer has a different protocol for doing that – check your owner's manual.

2566

2567

2568

2569

2570

On those rare occasions that I forgot to disengage my bike's ABS, it went something like this:

2571

2572

1. Corner coming up, or steep downhill in progress
2. Sharp braking was needed, so I hit the rear brake hard, and used 2 fingers on the front lever
3. Bike isn't slowing much – what's going on?
4. I felt the rear brake lever start to pulsate rapidly
5. The rear wheel started to skid, then grip, skid, then grip
6. Pucker factor went off the chart and at the same time the "I'm An Idiot" light flashed in my head
7. Each time it's happened I've barely managed to avoid a tumble
8. I came to a stop, cursed my stupidity, and disengage the bloody ABS system
9. I vowed never to let it happen again. But occasionally I still forget. I'm a slow learner.

2573

2574

2575

2576

2577

2578

2579

2580

2581

2582

To convince you that ABS is a bad idea, take your bike out on a dirt surface. Leave the ABS engaged. Come up to about 10 MPH and stab the rear brake as hard as you can. You'll experience a lack of braking and a pulsing feeling that will make you a believer. It's very unsettling. ABS isn't needed or wanted when riding Off Road. Turn it off.

2583

2584

2585

2586

2587

Off Camber Surfaces

2588

2589

Off camber refers to surfaces that are neither uphill nor downhill, because you're crossing the slope at an angle. To do this properly and safely, push the bike toward the ground on the "uphill side". Move your body away from the slope and place the motorcycle "beneath" you, closer to the slope. This method seems counter-intuitive, but it works. It also improves traction because your weight is forcing the tread downward into the ground.

2590

2591

2592

2593

2594

You don't want to put your body on the inward side, between the ground and the bike. If you put yourself there, you'll lose traction. The bike will want to fall away from you, heading down the slope, and you'll be powerless to stop it.

2595

2596

2597

2598

2599

2600

This next section of trail is challenging because it combines a lot of loose round rock, an off-camber surface, and a steep hill. There's also some big ruts filled with stones. If you drop into the rut you'll have a tough time climbing out,

2601

2602

2603

2604

2605

2606



2607 Whether I'm coming up the slope or going down, I'm pushing the bike sideways into the hill.
2608
2609
2610
2611



2612
2613 These photos show opposite sides of the same trail. Loose rock discourages riding down the middle of the road, so
2614 the safest route is along those off-camber edges. I push the bike into the hill, moving the bars laterally.
2615
2616



2617
2618
2619

2620 These stick figures show how to cross an off camber surface. The guy on the left is doing it **WRONG**. His hips
2621 are between the bike and the uphill slope. The guy on the right is doing it **RIGHT**. He's putting the bike between
2622 his hips and the slope of the hill.

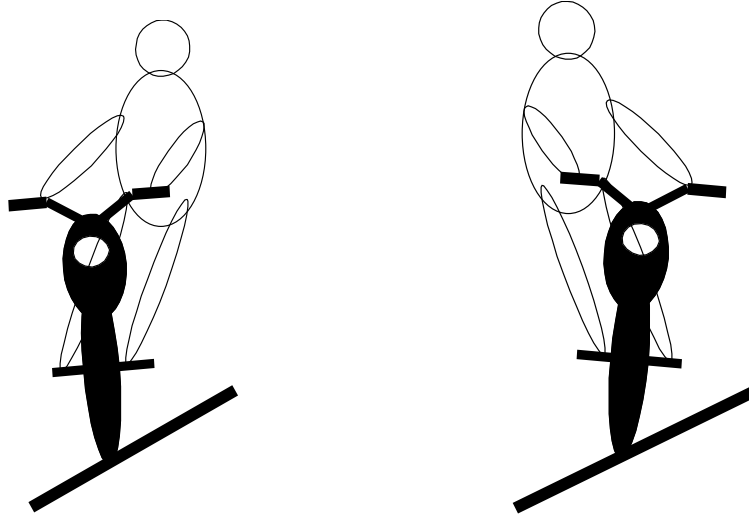

2623 (Note - I've ridden with both of these guys at one time or another. They're twin brothers, neither one is very bright
2624 and they don't talk much, but at least they don't eat much of the camp grub.)
2625
2626

2627 Terrain Identification

2628
2629 Nobody can be 100% certain about the terrain ahead and the traction it provides, just by looking at it. Sometimes
2630 you'll have to walk or ride across a surface, gingerly testing it to see how it "feels". Here's a few general rules of
2631 thumb when it comes to visually identifying road and trail surfaces, and the traction they provide. Some of these
2632 descriptions seem pretty obvious, but remember that this Article is written for riders who don't have any OR
2633 experience, so they might not be aware of traction issues with these surfaces.
2634

- 2635 1. Wet clay is slick. It also tends to pack into your wheel wells, bringing tire rotation to a dead stop.
- 2636 2. Wet leaves are slick because the leaves slip across each other as though they're lubricated. Even dry
2637 leaves can act this way.
- 2638 3. Cow pies are slippery, even the ones that appear to look dry. Please don't ask me how I know....
- 2639 4. Pine needles are slippery regardless of whether they're fresh and bright green or dried out and brown.
- 2640 5. Grass is slippery; wet grass even more slippery. At least grass is relatively soft when you fall on it.
- 2641 6. Loose gravel can shift beneath the wheel. If the gravel is made up from crushed rock then it has better
2642 traction than gravel made up from round river rock. River rock acts like marbles when your tire rolls over it.
2643 In the areas where I ride my KTM (and where the hill climbing photos were taken), the ground is made up
2644 from round rocks measuring from an inch to a foot in diameter. When the wheel hits one of those rocks it
2645 rolls sideways and traction is lost.
- 2646 7. Bare packed dirt usually has pretty good traction unless it's really wet, then it turns into mud. Duh.
- 2647 8. Loose dirt can have good traction, especially after a heavy morning dew or a very light rain shower; after
2648 that happens traction is at its best. Be watchful for puddles.
- 2649 9. Bare dry rock usually has good traction. When it's wet all bets are off. Wet rock is always slippery,
2650 especially when covered with moss or lichen.

2651
2652
2653
2654
2655
2656
2657
2658
2659

2660
2661
2662
2663
2664
2665
2666
2667
2668
2669
2670
2671
2672
2673
2674
2675
2676
2677
2678

10. Mud puddles can be deeper than expected. Don't trust them. Mud puddles were fun when you were 5 years old. They're not fun any more. I've seen a rider cruise into an innocent looking puddle that was just a few feet across, only to discover that it was also 2 feet deep. The crash was spectacular.
11. The edge of a mud puddle can be just as slippery as the center of the puddle itself. Use caution.
12. Stream crossings are always slippery and moss covered rocks are downright dangerous.
13. Logs and branches are usually slippery. The bark breaks free from the core and your tire will slip sideways. This happened to me recently on an overgrown mountain trail. My front tire rolled over the hidden branches OK, but when the rear wheel hit them they kicked up out of the ground, the wet bark tore loose and the bike took an immediate 90-degree turn. I kept going straight and plowed a furrow in the soft trail with my helmet. No real damage done, nothing I haven't done before.



2679
2680
2681
2682
2683
2684
2685
2686
2687
2688
2689
2690
2691
2692
2693
2694
2695
2696
2697
2698
2699
2700

The best OR riders are those who can judge the road/trail surfaces accurately and make good judgments about the available traction. That allows them to select the appropriate path and technique for that particular terrain.

Crossing Water Obstacles

Everyone's seen photos of bikes crossing streams or rivers. Those really cool photos show a beautiful V-shaped spray of water coming off the bike. Here's the real truth about water crossings – somewhere under the surface there's a big round rock with your name on it. Your front wheel will hit it and deflect unexpectedly, causing you to crash. Your bike will suck water into the air cleaner, filling your cylinders. You're in for a heck of a time cleaning it out.

Cross water obstacles with great care, don't try to be a hero. If you can't see the bottom of the



2701 water, walk across first and use a stick as a probe to test the depth and the riverbed makeup. Remove any
2702 obstacles if necessary. Detour if you're not comfortable with the crossing. I've ridden 20 miles out of my way to
2703 avoid a bad water crossing. I might have made it across safely, but the risks were just too great and the benefits
2704 were marginal.

2705
2706 Photo below left shows Steve carefully approaching a small water crossing. The water was clear and he could see
2707 that the bottom was hard gravel. Photo below right shows a water crossing that looked suspicious – the water was
2708 murky. A reconnoiter on foot and careful probing with a stick determined that the bottom was soft and the depth
2709 was almost 3 feet. Remember the old saying "still waters run deep"? They do. We detoured around that creek.
2710



2711
2712 If the water's not too deep and the base of the trail is in good condition, you can stand on the pegs as you ride thru
2713 the water. Be prepared to dab one foot if the bike slips on some rock.
2714
2715



2716
2717 Check out the depth of the water before you commit. Get off the bike and walk. Walk right down into the water or
2718 use a stick as a probe. Pick a line thru the water that offers the best chance of success. Test the bottom using a
2719 stick.
2720

2721 If the water's more than about 18" deep, or if there's stones that might cause you to fall, then standing on the pegs
2722 might not be the best method. You might be forced to "dog paddle" thru the water, with your butt in the saddle and
2723 both feet on the ground. Use your feet as outriggers to keep the bike upright. Using clutch and throttle, keep the
2724 rear wheel spinning as you walk the bike forward. Don't stall the engine!
2725

2726
2727 If you fall in the water, quickly turn off the ignition. Get the bike upright, assess whether the bike sucked water into
2728 the cylinders. If it did, then you'll have to push the bike to the bank. Remove the spark plugs. Push the starter
2729 button (or use the kick starter) until all the water is purged from the cylinders. Reinstall the plugs and start the bike.

2730 Why is a spark plug removal necessary? Water doesn't
2731 compress. If there's water in the cylinder, then the force of
2732 the pistons going up against the cylinder head will meet an
2733 immovable object – water. Something will break.

2734
2735 If the bike didn't suck in water (both exhaust and intake were
2736 well above the water level) then you may be able to restart
2737 the engine mid-stream in the water. Once started, stand
2738 alongside the bike and push it forward as you slip the clutch
2739 and spin the rear wheel. Walk the bike out of the stream.

2740
2741 Every puddle in the road should be considered to be a water
2742 obstacle. You never know what lurks beneath the surface.
2743 When I was 5 years old I enjoyed playing in puddles, thinking
2744 it was great fun. These days I avoid puddles the same way I
2745 avoid speed traps – I pay attention and I slow down.

2746
2747

2748 **Riding In Gravel**

2749

2750 A lot of OR'ing takes place on gravel surfaces. The gravel might be compacted to the point where it's almost like
2751 riding on pavement, or it might be loose and unpacked which makes the bike feel unstable, almost like you're riding
2752 on marbles. You are, actually.

2753

2754 The type of gravel on the road surface has an impact on how it feels as you ride across it. If the gravel is crushed
2755 and has sharp edges, that's good. It will grip your tires and it will grip other pieces of gravel as your tire rolls across
2756 the surface. If the gravel is smooth like round river rock, then that's bad. The gravel won't grip your tire and the
2757 stones won't get along well with the other bits of gravel. You truly are riding on a road made of marbles.

2758

2759 I'm sure you've been on mountain passes and have seen emergency truck runaway ramps. It's not the up-slope of
2760 those ramps that slows down the careening 18-wheeler, instead it's a bed of round gravel. Once the truck hits that
2761 gravel the tires dig in and the truck comes to a safe (but abrupt) halt. It takes a heavy duty wrecker to pull the 18-
2762 wheeler out of the trap. So it will go with you and your bike if you venture into a bed of loose round gravel. Your
2763 bike will be captured like a fly in a web. More than likely you'll fall in the process. For these reasons use great care
2764 when riding thru round loose gravel.

2765

2766 Regardless of the size or consistency of the gravel, the riding technique you'll use is the same. You want to keep
2767 your weight to the rear. This allows the front wheel to hunt-and-peck back and forth as it travels over the surface. A
2768 light front end keeps the front wheel from plowing or digging into the gravel. A heavy front end causes the bike to
2769 dig in and wallow uncontrollably.

2770

2771 If you're riding across a patch of deep gravel, you'll want to keep on the throttle, accelerating gently. Don't chop the
2772 throttle or the front end will dive and the bike will become unstable and you'll have a hard time controlling things.

2773

2774 If you're riding thru long stretches of gravel there's a limit to how much you can continue to "gently accelerate".
2775 You'll have to set a comfortable maximum speed. Mine's about 50 mph; above that speed I start to get nervous,
2776 and nervousness makes for fatigue. Once you reach a certain velocity the bike will tend settle down and things will
2777 stabilize, assuming you're keeping your weight to the rear. Finding that maximum velocity is the trick, and you only
2778 find it with practice. Each road surface is different.

2779

2780 When you ride on gravel surfaces the handlebars will feel wobbly and unsettled, almost as though they're mounted
2781 on rubber. Most riders try to hold the bars in a firm grip, but that's NOT what they should do. Instead they should
2782 relax their grip and allow the bars to wander a bit, moving slightly within their hands. Keep your elbows loose.
2783 Don't get tense. Don't try to "man-handle" the bars. And don't panic.

2784



2785 You won't be making sharp turns in gravel. Directional control won't come from physically turning the bars left or
2786 right - instead it comes from subtle movements of your knees against the tank, your toes on the footpegs, and your
2787 body positioning on the bike. Instead of "turning" the bike, you'll be "heading" in a certain direction.
2788

2789 To head to the right, push down with your right toe on the footpeg and press in on the left side of the gas tank with
2790 your left knee. To head to the left, push down with your left toe on the footpeg, press in on the right side of the tank
2791 with your right knee. Try to resist the temptation of moving the handlebars left or right. Move them laterally.
2792

2793 Think of this as an equestrian technique. The cowboy doesn't "turn" the horse with the reins. Instead he puts more
2794 weight in one stirrup, presses against the horse's neck with his knee, and the horse heads in the desired direction.
2795

2796 One accessory that really helps when riding in gravel is a steering damper (stabilizer). With the damper in place I
2797 pretty much ignore patches of gravel. I pick my line on the trail ahead and the bike stays straight and true. I've got a
2798 Ralle-Moto damper one on each of my bikes and it makes a huge difference. The stabilizer acts like another set of
2799 arms on the bars, reducing my fatigue, and taking that unsettling feeling out of the front end. Another good steering
2800 damper is made by Scotts. Get one if your budget permits. Dampers also improve the bike's stability in sand.
2801

2802 The techniques you'll use for riding in gravel also translate to riding on other surfaces. Read on to learn why.
2803
2804

2805 Riding in Sand

2806

2807 Few things bring on an anxiety attack like a long
2808 stretch of deep sand. It's the bane of many riders
2809 and they don't mind confessing publicly that they've
2810 never mastered that challenge. I'm one of them.
2811 I've ridden in sand but it's not something I really look
2812 forward to doing, especially aboard a heavily loaded
2813 motorcycle.
2814

2815 This photo was taken in New Mexico, just north of
2816 Interstate 10. Steve dropped his 1150GS at a fairly
2817 low speed. No harm done. We had another 2800
2818 miles to go on the CDR. Steve's fall wouldn't be the
2819 last one of the journey. We both had opportunities
2820 to practice our bike-lifting techniques. There was
2821 sand, sand, sand, as far as the eye could see.
2822

2823 1. When riding in sand the first thing to do is to
2824 drop tire pressure. Go as low as you can,
2825 depending on the conditions ahead. If
2826 you've only got 100 yards of sand, followed
2827 by miles of sharp rocks, then you can't drop
2828 the tire pressure very much, because as
2829 soon as you get to the rocks you run the risk
2830 of rim damage or puncture. However if your
2831 course follows a sandy streambed for the
2832 next 5 miles, I'd drop tire pressures to the
2833 bare minimum and re-inflate the tires when I
2834 finally reach the rocky bits.
2835

2836 2. If you're stuck in the sand, remove as much
2837 baggage and other gear as possible. The
2838 lighter you can make the bike, the easier it'll



Steve and I removed gear for this short section of bad sand & mud

2839
2840
2841
2842
2843
2844
2845
2846
2847
2848
2849
2850
2851
2852
2853
2854
2855
2856
2857
2858
2859
2860
2861
2862
2863
2864
2865
2866
2867
2868
2869
2870
2871
2872
2873
2874
2875
2876
2877
2878
2879
2880
2881
2882
2883
2884
2885
2886
2887
2888
2889
2890
2891
2892
2893

be to escape the sand. You should also consider removing panniers. Carry the gear a short distance to firmer ground along your intended course. Once you clear the sand you can reload your gear. In this next photo Steve and I reload the bikes after portaging our gear across a bad stretch of mud and sand.

3. If you're stuck in the sand, dig away any berms that have built up in front of the tires. Create a smooth ramp leading up and out of your rut. This photo shows a sand berm in front of the wheel. If I don't kick that sand out of the way, I'm going nowhere.
4. To get moving again in sand you'll need to become a Master of clutch and throttle. Too much throttle and the rear wheel will dig a hole. Too little throttle and the engine will stall.
5. If you're throwing up a huge rooster tail, that's a sign that you're using too much power or you're using it ineffectively. Use your clutch to moderate the power going to the rear wheel. You'll be slipping it heavily. There will be some roost from the rear wheel, but not something worthy of the cover of a magazine.
6. If you're riding a BMW with a dry clutch you'll experience a pungent smell of burning clutch. Don't worry, the clutch can take it for quite a while. If you're on a bike with a wet clutch system you can slip the clutch all day long without any worries.
7. If you're REALLY stuck in the sand, stand alongside the bike and use maximum pushing effort with your legs, both hands on the bars, engine running, clutch slipping. Power out of your hole. You can usually only do this for a few feet before you're physically worn out. Hopefully you've gained some ground.
8. If you're only moderately stuck in the sand, sit astride the bike. As you rev the engine and begin to engage the clutch, lean forward and push off with both legs. You're encouraging the bike to begin moving forward. If you have a buddy with you they can give you a push to get you started.



This photo shows the Patient and Long Suffering Wife giving me a push. She did this a couple times before she told me I was on my own. If I recall her exact words she told me I could "go pound sand", or something to that effect. I got the message.



2894
2895
2896
2897
2898
2899
2900
2901
2902
2903
2904
2905
2906
2907
2908
2909

9. Once you begin forward motion you can dogpaddle a step or two, but as quickly as possible stand on the pegs and shift your weight back. Get your butt as far back over the rear wheel as you can. Stretch your arms straight, almost as though you're pushing the bars away from you. Don't lock your elbows.
10. Hold the bars lightly – don't over-steer, over-correct, or try to manhandle the front end. It's going to feel light and wobbly – that's normal when riding in sand. You'll just have to get used to it. Remember to look for the web between your thumb and index finger. If you can see a gap there, then you're holding the bars properly. If you don't see the web, then loosen your grip and lift your elbows.
11. Keep your RPM up – don't let the engine bog down. Gradually accelerate and you'll begin to "plane" over the top of the sand. Like a speedboat that comes up on top of the water surface, your bike will start to glide and the bike takes on a new persona. On this long stretch of beach as long as I kept my speed up I did well. When I slowed down the bike would wallow and dig in. If you look closely at my track, you'll see that at the lower right my tires made a deep trench – I was going slowly. But as I came up to speed, my tires dug in less and less and soon I was skimming across the surface, barely leaving a track.



2910
2911
2912
2913
2914
2915
2916
2917
2918
2919

12. Keep moving – he who hesitates is lost. Once you slow down or come to a stop, you'll dig in. Then you'll have to start all over again.
13. To make a turn, use the same techniques as you would when riding in the dirt. Keep your RPM up because if you bog down you'll sink again. If you're making a sharp turn you could try planting a foot on the inside of the turn and use lots of throttle to spin the bike sideways. That's an advanced technique, probably above the pay level of most of those reading this Article.

2920
2921
2922
2923
2924
2925
2926
2927
2928
2929
2930
2931
2932
2933
2934
2935
2936
2937
2938
2939
2940

14. Many riders think that they have to be continually accelerating whenever they're riding in sand. They imagine a scenario where they started out at 5 MPH and the sand trap was a long one, so now they're doing 80, with no end in sight. The idea of constant acceleration in sand is a bit of a misnomer. Yes, you accelerate, but you only build up enough speed so the bike stabilizes itself, while you limit your speed to a safe and reasonable limit. My personal limit when riding in sand is about 35 MPH. Some riders might be able to do 50, but that's above my limits.
15. If the sand/mud trap is extremely deep or extremely long, you may find that standing on the pegs (your butt pushed back over the rear wheel) is simply not working for you. There's an exception to every riding technique. It may be necessary to drop your butt in the saddle and use your legs as stabilizers, keeping the bike upright. Even the most accomplished rider has to do that from time to time, if things get really tough.
16. In this next photo Steve's riding across a wash filled with mud and sand. The night before there was a heavy thunderstorm and resultant flash floods. We spent the day dodging washouts like this one. I made it across the arroyo to take the photo, but for Steve it was a different matter. There was no choice but for him use his legs as a pair of outriggers so he could keep the bike upright. On a lighter bike the crossing would've been much easier. Excess weight is your enemy when riding in sand.

(Those tire tracks across the streambed are mine. The footprints were left when I walked back to Steve and gave him a pep-talk)



2941
2942
2943
2944
2945

2946

2947

Riding in Snow

2948

2949

2950

2951

2952

2953

2954

2955

2956

2957

2958

2959

I've never intentionally ridden in the snow on a large dual-sport bike, but I have been caught in the snow and had to ride down out of the hills. Of course a few inches of snow will make traction very difficult to find. If the snow's not too deep and the temperature's not too cold, the tires will push thru the snow and hook up with the underlying soil. If that's the case then traction isn't too bad. Ride slowly, head to lower elevations. You can ride on the pegs, but slowly, gingerly. Be prepared for quick foot dabs to regain your balance. Keep your weight to the rear. Use brakes with extreme caution, relying mostly on the rear for stopping power. Use the throttle very carefully.

These next photos were taken on the Magruder Corridor between Idaho and Montana. Late September. Not a soul around for 50 miles in any direction. I was on my own. Fortunately the snow only lasted a couple miles. I was running Tourance tires, instead of TKC-80 knobbies. I regretted my tire choice.



2960

2961

2962

2963

2964

2965

2966

2967

If the snow is deep, or the ground is frozen, then traction is minimal and you've got a challenge ahead. You'll probably drop the bike somewhere along the course. It only takes a millisecond – one moment you're upright and the next moment the bike is down. In these conditions I recommend you don't stand on the pegs – there just isn't time to make a correction if your legs are 12" off the ground on the pegs. Instead keep your butt on the saddle and use your legs like outriggers. Snow like you see below is best left to smaller bikes like the KTM.



2968

2969

2970

2971
2972
2973
2974
2975
2976
2977
2978
2979
2980
2981
2982
2983
2984
2985

Riding in Mud

As with snow, mud presents similar challenges. Mud, has one added weapon – it doesn't warn you about how deep it is, or what lies beneath. From the top view, a mud puddle or a muddy stretch of trail may look harmless but it can be hiding secrets beneath the surface. Who knows how deep it is, or what ruts are lurking below? I treat mud with the utmost respect. Usually I keep low (off the pegs) and use my legs as outriggers. After a short distance, if the mud seems manageable I'll stand on the pegs, keeping weight to the rear. I reduce speed, and I'm always ready to dab a foot to keep my balance. Use care with the front brake.

Mud is the one thing that can bring a planned ride to a screeching halt. On a Continental Divide Ride I detoured around a few sections because the roads ahead were impassable. Even if I could've kept the bike upright, the mud was of a consistency that would've packed the wheel wells until it jammed the wheel against the fenders. When that happens you're really in trouble. You can clean the mud, but in a few feet it will pack-up again. Perhaps the best thing to do is pitch your tent and wait for things to dry out.



2986
2987
2988
2989
2990
2991
2992

Ahead lay 100 miles of dirt roads, and there was a fast moving storm coming my way. What would you do? I did the prudent thing and went back the way I came. As I rode out of the area a local rancher flagged me down. We visited for a few minutes and he told me that the roads ahead got so bad when they were wet, that it was impassable to 4x4's and ATV's. He said he couldn't imagine anyone riding out there on a motorcycle.



2993

2994
2995 If the sun's going to come out in a couple hours,
2996 then perhaps you can wait for things to dry out. If
2997 the forecast is for several days of bad weather,
2998 then you probably want to switch to Plan B. You
2999 always have a Plan B, don't you?

3000
3001 I consider this photo at right to be solid evidence of
3002 what it means to have "a really bad day" riding in
3003 the mud. If I was Glen I think I'd be pretty
3004 discouraged. Of course after being kidnapped by
3005 communist rebels in South America and held for
3006 hostage, Glen takes most things in stride.

3007
3008 Photo courtesy of Glen Heggstad, the Striking
3009 Viking.



3010
3011

Riding A Forest Road

3012
3013
3014 When you're riding a forest road you'll want to be riding in one of the two "wheel tracks" that make up the roadway.
3015 The shoulders are probably grassy, as is the center strip between the two wheel tracks. The wheel tracks are
3016 usually packed gravel and usually offer the best traction. Be willing to switch from one track to the other, if the other
3017 track looks more favorable. Use care as you cross the center strip, especially if there's high grass that would hide a
3018 rock or stick or other obstacle. Gently accelerate as you cross the center strip and keep your weight to the rear.
3019



3020
3021
3022 Forest road etiquette usually demands that you keep to the right side of the roadway, even if it's a single lane road.
3023 Legally you're probably entitled to the entire width of the roadway, just as if you were traveling in a 4-wheeled
3024 vehicle. However if you meet another vehicle coming your direction, you'll need to share the road in some fashion.
3025 This means that both vehicles slow down and one of them makes way for the other. Often one vehicle will wait at a
3026 wide spot in the road, while the other vehicle eases past. Since you're on 2 wheels you can usually sneak by on the
3027 shoulder.

3028
3029 Regardless of the rules of the road or forest etiquette, if you meet another vehicle on a blind corner you'll lose the
3030 battle. Use caution when approaching blind corners, and always be ready to move to the shoulder.

3031
3032 I once met a logging truck on a blind corner. It happened in a split second. He was swinging wide to make the
3033 curve, and his bumper was in my track. Fortunately I was anticipating just such an event, so I was quickly able to
3034 swerve wide and let him pass. In the photos above I should be to the far right, in case another vehicle comes my
3035 way.
3036

3037 Vehicles coming downhill have the right of way simply because they have difficulty stopping on a grade, so be
3038 prepared to move over and yield as needed.
3039

3040 On a really narrow road it may be dangerous to move all the way to the right to yield right of way. This would be
3041 true if there was a sharp drop off or other hazard. Where should you go? Off the cliff? No, your only solution is to
3042 quickly move to the left side of the road, hugging the shoulder in the opposing lane. This moves you away from the
3043 shoulder and the dangerous drop-off, allows you to put your foot down and stabilize the bike, but it still allows the
3044 oncoming vehicle some room to pass you on your right. I've used this technique a number of times.
3045

3046 Riders in the UK, Australia, and left-side-of-the-road parts of the world will obviously need to reverse the scenarios
3047 described above. (Do I really need to tell you that?) I suppose that after seeing Steve Smith upside-down BMW
3048 photo, perhaps my precautionary warning is in order.
3049
3050

3051 **Riding a Single-Track Trail**

3052 Even a fully loaded big bore motorcycle can travel a single-track trail that's in good condition. Don't let the fact that
3053 it's a "trail" keep you from enjoying the ride. It all depends on your skill level and your willingness to encounter
3054 some unexpected adventures.
3055

3056 Most riders avoid trails because they don't know what lies around the next turn. Will the trail suddenly transform
3057 from being wide and smooth, and turn into a narrow steep nightmare? Maybe. It's always good to do some
3058 research and find out what's ahead on the trail before you venture too far.
3059

3060 To take some of the worry out of trail riding, read and practice the techniques for turning the bike around on a
3061 narrow road/trail. See the Turning Around On A Trail section.
3062
3063

3064 Know your limitations. If you see the trail is getting worse or if you feel uncomfortable, it's time to stop. Don't wait
3065 until you're in a really tight spot before you decide to turn back. It's a real hassle to try to get turned around on a
3066 single-track trail, especially if the trail is heavily wooded or on a steep slope. When that happens you'll probably
3067 need to use the Motorcycle Recovery System.
3068

3069 As you ride single-track, be aware of the width of your engine case, crash bars, and saddlebags. Watch for rocks
3070 sticking out of the hillside that would snag something, tear a hole, or throw you off course. Also watch for low
3071 hanging branches that can snag your helmet. I once had a branch catch my helmet visor and nearly lift me off the
3072 bike. I was standing on the pegs and misjudged just how "tall" I really was in that standing riding position. I guess
3073 being tall isn't always a benefit... us short folk usually stay beneath the radar and the branches.
3074
3075

3076 **Riding In Ruts**

3077 It would be nice if the road or trail was always
3078 smooth and level, with no ruts. It would also be
3079 nice if there was world peace and we could all
3080 get along with each other. Don't hold your
3081 breath.
3082

3083 Ruts are caused by erosion or by a 4 wheel
3084 vehicle that drove on the roadway when things
3085 were muddy. Whatever their cause, ruts should
3086 be handled the same way – avoid them
3087 whenever possible. That doesn't mean you
3088 can't ride down a road that has deep ruts, you
3089 just need to know how to handle them.
3090
3091

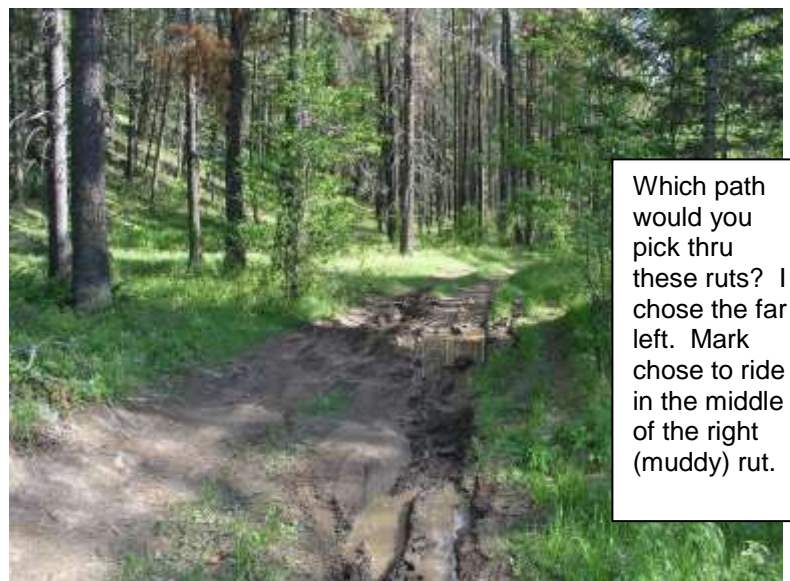

3092 When you encounter ruts you should ride on the higher portions of the road, either in the center between the ruts, or
3093 on the shoulders outside of the ruts. It's usually good idea to avoid riding in the bottom of a rut. Ruts can be filled
3094 with rocks, mud, sticks and other dangers. Ruts seldom run in a nice straight line – instead they wander back and
3095 forth. If you're in the bottom of the rut and it takes a sharp turn, your front wheel will automatically follow the rut.
3096 The rest of the bike (including you) won't. The result is a tumble.

3097
3098 It's difficult to appreciate the depth of the ruts and the difficulty of the terrain shown in these photos. These ruts
3099 were caused by 4x4s when the road was muddy. Their passage created a series of ruts, soft spots, mud holes, and
3100 bumps that could easily catch a rider off guard. The only safe path was to ride far to one side, next to the trees.

3101
3102 As my life-long buddy Mark rode thru one of those puddles on his heavily laden BMW R1150GS, a large stick
3103 popped up from below the water's surface and snagged his skid plate. It caused him to lose balance and he went
3104 down in the deepest part of the largest puddle. He was literally covered with mud, helmet to boots.

3105
3106 Once I saw he was OK and unhurt, I started laughing. I laughed so long and so hard that I forgot to take photos of
3107 his mishap. One of the joys of sharing the OR experience is being able to find humor in the midst of any situation,
3108 especially when your riding buddy's the one in trouble. You can ask forgiveness later. For now, just laugh.
3109



3110
3111
3112 The next photo shows another section of road and a series of ruts. The road's not quite as narrow as the previous
3113 photos, but this section is every bit as tricky. The soft soil and poor lighting contrast made it hard to see where the
3114 ruts started and stopped. The best path was at the far right, on top of a small berm. Then you had to make a
3115 transition to the far left toward the top of the photo. These ruts continued for several miles and for a while it was a
3116 real Rut Rodeo. After a while actually it became fun as we dodged the hazards. Remember the old adage: if you're
3117 given a few lemons you might as well make some lemonade.
3118
3119



3120
3121
3122
3123
3124
3125
3126
3127
3128
3129
3130

Speaking of ruts, several years ago I was riding a trail bike at a brisk pace thru a Montana cow pasture. The sagebrush was pretty high but the cows had trampled down a nice single-track trail thru it all. The dirt trail was about 3" lower than the rest of the prairie. The trail went on for several miles and I had no problem following it as it gently wound over hill and dale. It was a wonderful day, sun shining, birds singing, etc. Suddenly the trail took a sharp left, catching me off guard. Before I could slow down enough to climb out of the rut, the front wheel deflected along with the rut, while the rest of us (the bike and I) kept going straight. I woke up a couple minutes later to the sounds of bluebirds singing. Lesson learned – ruts will quickly take that front wheel wherever they decide they want it to go, and they'll do it without mercy or any warning. If you ride in the bottom of a rut, or in a scalloped trail, be ready for anything.



3131
3132

3133
3134
3135
3136

In the next photo the rut was filled with large round rocks. Going down into that rut would result in a tumble. The best path was along the crest between the two ruts.



3137
3138
3139
3140
3141
3142
3143
3144
3145
3146
3147
3148
3149
3150
3151
3152
3153
3154

If you can't ride on the high portion of the road and you find yourself down in the rut, slow down and look for an opportunity to climb back out. If you can't climb out you may have to come to a complete stop and shovel out a small ramp so you can regain the high shoulder or center strip.

When riding the Continental Divide Route, there were many sections with bad ruts. Some I could avoid, some I couldn't. I'd ride down into the bottom of a rut for a few feet, then as soon as I could I'd climb back up the other side and regain "high ground". It became a bit of a game and provided some fun along the journey.

You CAN ride up and out of a rut; you just need to know how to do it. Motorcycle tires DON'T like climbing up a sharp shoulder when the tire meets that sharp shoulder at a slight angle. In street riding class you learned to you avoid crossing a railroad track at a slight angle – instead you were taught to cross at a perpendicular angle or as close to that 90-degree angle as possible. With ruts you seldom get a chance to cross at a right angle, instead you're crossing them at very small angles. You have to pick a spot on the edge of the rut that the wheel is able to roll up and out of the rut. If you expect the wheels to climb up a 6" rut without some kind of help, you're in for a surprise.

3155 This photo shows ruts filled with water and mud. The high edges were soft sand. The safest way to cross the creek
3156 was to put the tires in the ruts at the very beginning, because they were eventually going to end up in there anyway.
3157 You can see my tire tracks in the right rut.
3158



3159
3160
3161
3162
3163
3164
3165
3166
3167
3168
3169
3170
3171
3172
3173
3174
3175
3176
3177
3178
3179
3180
3181
3182

Rules of thumb when it comes to ruts:

1. Treat them with respect. If you don't, they'll bite you.
2. Slow down when riding in the bottom of a rut or along the edge of a rut.
3. Cross them at a right angle (perpendicular) whenever possible.
4. Climbing out of a rut requires the proper spot (a small ramp of earth, natural or manmade).
5. If your front wheel's in a rut and the rut takes a sudden turn, your front wheel will probably follow the rut.
6. If your rear wheel's in a rut and you try to climb out of it, the wheel will slew sideways for a few feet, before the wheel climbs out of the rut. In extreme cases the bike will fall down.
7. If you're on the edge of a rut and you lose your balance or the bike starts to head down into the rut, don't fight it. Just ride down into the rut. If you try to "save it" by clawing along the edge of the rut, the bike's probably gonna fall down.
8. Don't take a chance of falling because you're trying to avoid the rut – just surrender to it, then make plans to ride along in the rut until there's a place to climb out.
9. If the rut's so deep and narrow the foot pegs or cylinder heads or panniers are scraping the sides of the ruts, it's best to come to a quick stop. Get out your shovel and dig a ramp that'll lead you to safety.
10. Ruts tend to collect sticks, stones, broken bottles, trash and other hazards. Don't put your tires at risk unless absolutely necessary.

3183
3184
3185
3186
3187
3188
3189
3190
3191
3192
3193
3194
3195
3196
3197
3198
3199
3200
3201
3202
3203
3204
3205
3206
3207
3208
3209
3210
3211
3212
3213
3214
3215
3216
3217
3218
3219
3220
3221
3222
3223
3224
3225
3226
3227
3228
3229
3230
3231
3232
3233
3234
3235
3236

Jumps and Whoops

There are few things that do a better job of evoking the concept of two-wheeled adventure than an action photo of a big-bore dual-sport motorcycle, momentarily suspended three feet off the ground. Jumps look cool, but leave them to the experts. Don't try to ride like you're a Supercross star – you're not, and neither am I.

When your bike is loaded with gear, the last thing you want to do is to grab some air. It's not the air that hurts - it's the landing. Coming off a 3 foot jump puts a lot of strain on the suspension and the rider. It's not impossible for you (or me) to do, but it should probably be avoided. Leave the showboating for another time.

There are times when the terrain demands a certain amount of speed and momentum to achieve your goal, and that speed may mean that your bike becomes airborne for a second or two. In that case here's a few tips on how to handle it.

1. As the bike approaches the "launch point" pull back on the bars and twist the throttle. You're trying to lift the front end. With a heavy big bore motorcycle the chances of going over backwards are pretty minimal (unlike a lightweight trail bike or motocross bike which can go over pretty easily).
2. At the same time you pull back on the bars and roll on the throttle, shift your weight backwards, putting your butt over the rear wheel. Straighten your arms (don't lock your elbows).
3. When timed properly the front of the bike will be slightly higher than the rear as you leave the ramp, which means your rear wheel will touch the ground before the front wheel. You DON'T want to land on your front wheel because it will probably dig in, twist to the side, and plant you firmly in the ground. Been there, done that, not much fun.
4. As you land, allow your legs to absorb the shock. Keep the throttle rolled on, don't chop it as soon as you touch down. If you do then your weight will transfer forward and you'll have control issues.

Another situation where "jumping" is useful is if you're coming down a hill and there's a drop off. You've got to loft the front end as you leave the ledge; otherwise you'll be going off the edge with a nose-down attitude which is not good. Roll on the throttle as you approach the edge of the ledge. Even if you can't loft the front end you can at least lighten it somewhat, and that makes all the difference when you make your landing.

"Whoops" are large undulations of the road or trail surface. They got their name because of the verbal expressions made by riders who got sideways or upside down as they tried to ride across them. "Whoops" or "Whoop-de-do" is perhaps a better conversational expression than "OH MY GOSH I'M GONNA CRASH!".

Depending on the height of the crests and the distance between crests, the rider may need to use different techniques. A firm roll-on of the throttle might best handle small whoops. The bike will dance across the tops of the bumps and the suspension really gets a workout. This method is for advanced riders only.

The best way to handle larger whoops is to reduce your speed and allow the bike to ride down into the valleys and up over the crests, wheels never leaving the ground. Up-down-up-down; ride up to the crest then down in the trough. Develop a gentle rhythm as you ride up and down on those surfaces. Think of it as riding a wooden horse on a carousel. You might look silly, but you'll maintain control.

As you go down in the valleys, move your weight to the rear as though you're braking or going downhill. As you climb the crests, move your weight to the front and put your helmet over the handlebars. You'll get a workout doing this but it's the best way to maintain control. Slow and easy, nice and gentle.

3237 Crossing Logs and Other Obstacles

3238

3239 Just because there's a log across the road, doesn't mean you have to turn back. Perhaps you can cut the log with
3240 your saw or move the log out of the way with your Motorcycle Recovery Kit.

3241

3242 If the log is small enough you may be able to ride over it. The practical limit is about a 12" log, although I've gone
3243 over 24" logs on my KTM. To minimize the height of the log, you can build a small ramp leading up to the log by
3244 using sticks, rocks, and some dirt from the trail. Lay the sticks parallel to the log, and stack the sticks in a tight
3245 bundle. Pack the stacked wood with dirt to keep them from rolling when your wheel rolls over them. In 5 minutes
3246 you transform that 18" log down to a 4" parking lot curb.

3247

3248 Don't make the mistake of trying to build a ramp with branches that are placed perpendicular to the tree, with one
3249 end resting on the ground and the other end propped against the tree. When your wheel hits those branches it will
3250 drive them apart like a gigantic wedge and you'll fall down. I know this to be true. It was an interesting lesson.

3251

3252 Approach the log slowly in 1st gear at about 3-4 MPH. Keep your weight to the rear. As your front wheel touches
3253 the log allow just a fraction of a second for the front suspension to compress against the log. At the same moment
3254 that happens QUICKLY pull back on the bars (which will also bring your body forward into an **Charge!** position). At
3255 that same moment also pop the clutch and apply throttle.

3256

3257 These simultaneous actions will cause the front end to jump upward high enough so the front wheel will clear the
3258 log. Your forward momentum will carry your bike onto (and hopefully across) the log. Your skid plate may or may
3259 not slide across the log, and your rear wheel will claw up and over the log. If you don't use enough throttle you'll
3260 find your bike sitting astride the log, front wheel on one side, rear wheel on the other. You'll have to push the bike
3261 forward with your legs to get the rear wheel over the other side.

3262

3263 Tree bark can be slippery, so if you're crossing the log at anything other than a right angle, be prepared for the bike
3264 to slew sideways as soon as the wheels touch the bark.

3265

3266 Jumping logs requires a lot of practice in order to get the timing just right. I learned how to do it on a small dirt bike.
3267 I can do it over a small log on my BMW R12GS, but it's not very easy. Because log obstacles might not come
3268 around more than once a year, most riders don't practice for them. Too bad.

3269

3270

3271 Turning Around On A Road Or Trail - or- "U-Turns Made Easy"

3272

3273 Although it's nice to have a road or a trail that goes through to your intended destination, eventually you'll encounter
3274 a situation where the road or trail is blocked. That blockage can be in the form of a locked gate, a fallen tree, an
3275 impassable obstacle, or it might just be that you decided the course you were on wasn't really where you wanted to
3276 go. Whatever the reason, the ability to turn around on a narrow road/trail is a skill you need to master because
3277 sooner or later you'll be doing it. When it happens do it on your own terms.

3278

3279 Most of the time it's easiest to make a U-turn by moving the bike around to the left. That's because the rider is used
3280 to getting on and off the bike on the left, and because they can plant their left foot on the ground to steady
3281 themselves, while they keep their right foot on the brake pedal. In the following descriptions I'll be describing left-
3282 hand U-turns only. If you need to make a right hand turn, reverse these procedures.

3283

3284 Most riders don't really understand where their front tire is in relation to the ground... what I mean is they don't have
3285 a good spatial reckoning of where that front tire REALLY touches terra firma. The reason for this is because their
3286 point of reference is always taken from the saddle. Riders come to believe that the front wheel is further forward
3287 that it really is, and for that reason they compensate for the perceived location of the front tire when it comes to
3288 turning movements.

3289

3290 Why is the location of the front wheel that important? When you're riding OR and you go to make a turn-around,
3291 you often have to deal with rocks or other obstacles on the ground. Unless you know exactly where your front tire is

3292 in relation to that obstacle, your turning movements are made more difficult. I can't tell you how many times I've
3293 struggled making a U-turn because I misjudged the location of my front wheel in relation to that potato-sized rock.
3294 And I can't tell you how many times I've tipped over as a result of that darn potato-rock. From another rider's
3295 perspective it must've looked pretty funny – me dropping the bike because of a simple little rock. From my
3296 perspective it wasn't. Once I finally learned where my front wheel was, I stopped falling down. (OK, it still happens
3297 occasionally but let's not talk about it now)
3298

3299 On a 2-lane road the process of turning around is usually pretty easy. You might be able to do a sharp U-turn by
3300 turning the bars full-lock and you'll get the bike going the other way. Sometimes that U-turn requires a 2-point or 3-
3301 point maneuver. Turn as sharply as you can, then back up a bit, turn some more, back up, turn more, and
3302 eventually you're going the other way. If your legs are long enough you can do the backing-up process while you're
3303 aboard the bike. You're lucky if you have a 36" inseam. My 30" inseam makes the task a lot harder.
3304

3305 If you're like me, your backing up maneuver will be on tippy-toes because your legs are too short to get a good grip
3306 on the ground, especially if the surface is uneven or covered with gravel, dirt, etc. I must admit that I often need to
3307 dismount, stand alongside the bike and push/pull the bike to make the turns. As I make the turning movements, I
3308 lean the bike into my hips and allow my hips and legs to carry the weight of the bike. I don't try to control the weight
3309 of the bike with my upper body. I'm careful to keep the bike leaning up against me, because if it starts to tip away
3310 from me then I have no ability to control it. Once it "goes over the top" it's impossible to stop. All I can do then is to
3311 try to ease its passage to earth a bit. If I try to stop the fall I will only hurt myself, which I've done a number of times.
3312 Being a slow learner, I eventually came to terms with the fact that I'm not a weight lifter. I have to use good
3313 technique as opposed to brute force.
3314

3315 On a narrower road you won't have enough room for an easy full-lock U-turn. If you have enough road ahead of
3316 you, look for a wide spot to make your turn. Examine the edge of the road carefully, making sure it's solid enough
3317 for your wheels. (I've encountered soft roadsides that sucked the bike into the ditch). Swing your front wheel as far
3318 to the edge of the road as possible, and commence your U-turn. Knowing your front wheel's exact location and
3319 rolling path will give you an extra 12-24" of turning radius.
3320

3321 Let's say there's no "wide spot" and you're forced to turn around on a road that's not much wider than your bike is
3322 long. You're going to have to make a 5-or-6-or-8 point turn, making tiny turning movements until you achieve your
3323 goal. Push forward a few inches with the bars turned one way, back up a few inches with the bars turned the other
3324 way, repeat over and over until you make your turn.
3325

3326 Storing energy in your front forks can assist your backing-up movements. As you move forward push down firmly
3327 on the bars then apply the front brake at the last moment. Once stopped release the brake and use the rebound
3328 movement of the front fork springs to push you backwards. Assist the springs by pulling back on the bars. You can
3329 even use this technique to go backwards up a gentle slope. You only gain a few inches each time, but you will
3330 make progress, like a turtle.
3331

3332 If your road has an elevated berm along the side look for a place where you can roll your front tire UP against the
3333 edge of the hillside. Go up that slope a few inches and apply the front brake. What you're trying to do is to store
3334 some "gravity energy" in your bike, so that when the bike rolls backwards you can use that energy to assist you in
3335 your backing movements. One word of caution – when the front wheel climbs that slope, the distance from saddle
3336 to ground gets higher. If you have short legs you'll suddenly find that you can't touch the ground and you'll tip over
3337 like the guy on the tricycle in the 60's comedy "Rowan and Martin's Laugh-In". Been there, done that, stop laughing
3338 at me.
3339

3340 If you're going UP a slope then you can use the slope itself to assist your backing movements. You'll be performing
3341 a J-Turn. Go to the section of this Article that discusses turning around on a hill, and review those techniques.
3342

3343 If you're going DOWN a slope then it's a bit harder to make a U-turn because you'll be fighting gravity. Come to a
3344 stop as far to the right side of the trail as you can. Turn your wheel far left and let the bike roll around to the left in
3345 an arc. Use your left leg as your pivot point and keep your right foot on the brake. Depending on the slope and the
3346 width of the road, you may be able to turn the bars to the right and roll backwards slightly so that the front end is
3347 pointed upwards. If the slope is too steep and the trail is too narrow, I suggest that you lay the bike down gently on

3348 the uphill side. Step off the bike. Pull the rear end downhill a few inches until the front wheel is pointed uphill.
3349 Then remount and ride away.
3350

3351 Sidestand pivot: There's one U-turn technique that uses the sidestand as a pivot point for the motorcycle. This
3352 method allows you to turn the bike around in a radius no longer than the length of the bike. Here's how it works:
3353

- 3354 1. Unload all your gear. You need to minimize stress on the sidestand.
- 3355 2. Consider the obstacles on either side of the trail. Allow for the rotation of the bike.
- 3356 3. Ride as far to the right as possible, so you can place the sidestand in the center of the trail.
- 3357 4. Extend the sidestand. Plant it on a firm surface, avoiding soft spots. Use a hard section as a pivot point.
- 3358 5. Step off the bike and stand on the left side, holding the left bar your LEFT hand.
- 3359 6. Turn the bars full to the left.
- 3360 7. Place your RIGHT hand on the rear of the bike, near the back of the saddle.
- 3361 8. Pull the bike toward you so that the rear wheel leaves the ground
3362 (depending on the balance point of your sidestand, the front wheel or the rear wheel may come off the
3363 ground – adapt to your bike)
- 3364 9. Bring the bike up against your hips – this controls the leaning movement of the bike
- 3365 10. The bike will be balanced on the front wheel and the sidestand, stabilized by your hips
- 3366 11. Pivot the bike around to the left, allowing the front wheel to swing in an arc
- 3367 12. As the bike pivots, twist your hips and move your feet as necessary to maintain control
- 3368 13. Once rotation is achieved, release the bike and let the rear wheel down
- 3369 14. Reload your gear and ride away

3370
3371 Here's photos of the "sidestand spinning technique". First I show it with smaller bike, the KTM 450. I was doing this
3372 on a soft gravel surface that wouldn't support the small sidestand "foot". I found a large flat rock and used it as my
3373 pivot point. The bike balanced perfectly when I pulled it in against my hip. The process was actually pretty easy.
3374

3375 Sidestand deployed.



Pull bike toward you.



Wheels off the ground, bike is easy to spin



3376
3377



3378
3379
3380
3381
3382
3383
3384
3385

Next are photos showing the process of turning my BMW F800GS. The sidestand is a poor design, being mounted too far forward. It's clearly not strong enough to hold the entire weight of the bike. Adapting my techniques, I used the centerstand to pivot the bike. I used my emergency tow strap to secure the centerstand in the forward (down) position. If you don't secure the stand, it may fold up when least expected and the bike will fall on you. Been there.

Secure the centerstand with a strap. Pull the bike toward you so that it's able to pivot on the left side



3386
3387
3388
3389
3390

I found that the balance point of the bike was too far forward to allow me to spin the bike. I needed to add more weight to the REAR, so I loaded the right saddlebag. I could've loaded 2 bags, but then you couldn't see the technique.



My, what a BIG bike you have there, and you're such a little guy !
And your point is...?

3391
3392

Piece of cake! Well, not really. But it really can be done in the field, with a large bike, by a smaller person. If I can do it then you can too.



3393
3394
3395
3396
3397

Note: This technique places a HUGE amount of stress on the sidestand. Some bikes have side stands that will take the loads; others have side stands that are relatively weak. If you use this technique you may cause damage to the sidestand, so use caution and judgment. Heavy bikes like the BMW R12GS may not be able to use this technique.

3398
3399 The final (and ultimate) U-turn technique is to lay the bike over on one side on the ground, then spin it around to
3400 face the other direction. Of course this method will cause cosmetic damage to the bike, but it will get the job done.
3401 Unload your gear to make the turning movements easier. A fully loaded bike is tough to spin around on the ground.
3402 As you spin, also lift the bike as much as you can to reduce ground-to-bike friction and cosmetic damage. You can
3403 minimize damage and reduce friction if you put pine boughs, pine needles, or other vegetation on the ground before
3404 you lay the bike down.
3405

3406 The one rule of thumb when it comes to U-turns: TAKE YOUR TIME. Make a plan, and then carefully execute that
3407 plan. If the plan doesn't work, modify it as necessary. Whatever you do, don't work up a sweat or get winded or get
3408 frustrated.
3409

3410 **Riding With Other Motorcycles**

3411 Riding solo has certain benefits, but riding with others makes the adventure even more enjoyable. There's nothing
3412 like being able to share your experiences with close friends or family.
3413

3414 When you ride with others you need to allow plenty of space between each motorcycle. The tendency is for riders
3415 to bunch up and follow one another too closely. I know of many cases where good friends crashed into other
3416 friends because they were riding too close together. Now those good friendships are not so good anymore. I've
3417 nearly run into other riders myself, so I know how quickly and easily it can happen if you're not paying attention.
3418
3419

3420 When riding OR, you're going to be kicking up dust. Stagger your bikes far enough apart that the dust settles
3421 before the next bike arrives. This is the preferred group riding method and it's the safest technique to follow.
3422
3423

3424 If you're willing to take chances you can ride closer together so that the dust from the first motorcycle doesn't get a
3425 chance to kick up in the air before the next bike arrives. There's danger in this practice. Be forewarned.
3426

3427 If you're riding closely together, the tendency is for the next bike in line to watch the rider ahead. You tend to follow
3428 them as they pick their path down the road or trail, and you tend to mimic their technique and adopt their braking or
3429 acceleration points. Monkey see – monkey do. That can have mentoring benefits, but it can also be a handicap.
3430 When you watch the rider ahead, you stop making your own decisions. You get lazy or complacent, and when a
3431 situation comes up you're often unprepared to handle it because you can't see far enough ahead to analyze the
3432 upcoming obstacle.
3433

3434 If you're piloting the bike that's running at the head of the pack, you may feel like the rider following behind is
3435 "pushing" you. As a result you ride faster, taking chances that you wouldn't otherwise take. You get sloppy. You
3436 make mistakes. And you fall. Been there, done that.
3437

3438 If you're going to ride with others, then make the ride your own, keeping a safe distance. A 5-second interval
3439 between riders is good idea, because it gives enough space for both riders to do their own thing, and neither rider
3440 feels pressured into to do something foolish.
3441

3442 Group riding requires some planning. There should be a group gathering before the ride commences, where you
3443 have a discussion about destination, routes, fuel, terrain, difficulty, etc. There should be a designated leader (who
3444 knows where he's going). There should be a designated drag rider who brings up the rear, who acts as a shepherd
3445 for stragglers. There should be a protocol to handle forks in the road or trail. When I'm riding with a group, we
3446 always agree that when we come to a fork in the road, we wait for the rider behind us to catch up. Once he does,
3447 we indicate the direction of the group, and off we go. The other rider waits at the fork and passes along the
3448 directions before he continues riding. And etc. This method ensures that everyone arrives at the destination. We
3449 don't want anyone to get lost because then we'll have to waste riding time while we look for him or her.
3450

3451 If your group is spread out along the trail and you're not following the above protocol, then at least have a
3452 designated gathering point and schedule. "Our next rally point is Gobbler's Knob, and we'll meet there NLT 10:30",
3453 or something like that. You've established a destination and you've set a time limit. If Charley doesn't show up by

3454 11:00 you know that something's wrong and you can go back to assist with whatever's keeping Charley from joining
3455 the group. It could be a breakdown, it could be a tumble.

3456
3457

3458 Towing A Disabled Bike / Recovering A Fallen Bike

3459

3460 The day may come that you or one of your buddies needs to be towed out of the hills. It's not really that hard to do
3461 if you go about it properly. You'll need a tow strap at least 15 feet long. Longer is better. It should be at least 1"
3462 wide, or should be a type of rope that has a high tensile strength. The Motorcycle Recovery System (MRS) uses a
3463 rope that's perfect for this purpose. <http://www.bestrestproducts.com/c-168-recovery-gear-mrs.aspx>

3464

3465 There's several methods for attach a towrope between the TowER and the TowEE. Whichever method you choose
3466 make sure that the Tow-EE has the ability to disengage at any time. Only the TowEE will know when things go bad,
3467 so he needs to control the towing operation.

3468

3469 1. **An OK method.** Tie the strap to the rear of the towing unit. Run the strap back to the center of the

3470 handlebar on the TowEE. Wrap it around the handlebar twice, and let the TowEE hold the end of the rope in his clutch hand,
3471 hands on the bars. Begin towing. If things go bad the TowEE can let go of the rope and it will unwind itself from the handlebar.
3472 A disadvantage of this system is that the rope tends to pull the handlebars right and left, making it difficult for the TowEE to
3473 maintain control. Don't attach the tow rope to a bolt-on luggage rack on the bike. If you do there's a good likelihood that a
3474 sudden jerk on the rope will damage the rack. The stresses involved from towing a heavy motorcycle (with rider and all his
3475 gear) are substantial. If you have a windshield you can't attach to the center of the handlebars.



3476

3477 2. **A better method.** Wrap the rope twice around the TowER's right footpeg. Have the TowER step on the
3478 rope, which keeps it secure. Stretch the rope back to the towed motorcycle and wrap the rope twice around
3479 the TowEE's left footpeg. Have the TowEE step on the rope, which keeps it secure. Begin towing. The
3480 advantage of this system is that the strap doesn't pull on the handlebars, making it much easier to maintain
3481 control. Disengagement from the strap can be accomplished by either rider; all they have to do is lift their
3482 foot for a moment. You'll need some trial-and-error to determine the proper number of wraps around the
3483 footpeg. Too few and the rope comes off. Too many and the rope won't disengage when you lift your foot.
3484 The serrations of your footpeg tend to "trap" the rope, so if you have footpegs like the ones shown in this
3485 photo you need fewer wraps.

3486

3487 3. **A third method.** The disabled TowEE bike is in front, with the powered TowER bike in the rear. The
3488 TowER places his foot on the back of the TowEE's pannier or exhaust, and pushes the TowEE forward.
3489 The bikes are rolling nearly side-by-side. The advantage of this system is that no tow rope is needed; the
3490 disadvantage is that this method is fatiguing to the TowER and can only be done on fairly straight and level
3491 roads.

3492

3493 4. **This fourth method is the BEST in my opinion.** I'm using the Motorcycle Recover System (MRS) with
3494 webbing and carabiners, but you can use simple ropes if that's all you have. Substitute the carabiners with a
3495 simple loop knot in the rope. (Note that the basic MRS kit doesn't contain the 2nd piece of webbing needed for
3496 this setup. You can order the extra webbing as the MRS Auxiliary Towing Kit from BestRest.)
3497 The layout of the webbing and the rope keeps them above the wheels and prevents fouling of the wheels during
3498 the tow. A fouled rope will quickly bring a bike down.

3499

3500 Attach nylon webbing to the TowER's bike's passenger footpegs or nearby frame. Run the web up and over
3501 the seat AND/OR up and over the pannier frames. Keep the webbing away from the exhaust. Make sure the
3502 webbing won't press down on the taillight or otherwise cause damage to any component of the bike. When
3503 figuring out your routing method consider the fact that the system will have 500+ pounds of force applied to the
3504
3505

3506

3507

3508

3509

3510
3511
3512

system. Also consider that the straps/rope will make a bee-line from the attachment point to the towing line. What I mean is that the straps will pull along the shortest path. If some fragile part of the bike is in the way of the strap, then that part can be damaged, i.e. don't run the strap over the edge of your rear brake reservoirs.



3513
3514
3515
3516
3517

The way I've rigged my F800GS is perfect. I've attached the webbing to a sturdy frame member, I've routed up and away from the exhaust, and the rope attachment point is above my taillight.



3518
3519
3520
3521
3522
3523
3524
3525
3526
3527
3528
3529
3530
3531
3532
3533
3534
3535
3536
3537
3538

In the middle of the webbing attach a carabiner, which is where you will attach the tow rope. Keeping the rope attachment point along the middle axis of the bike makes towing much easier (than if it's off to one side).

If your rope's too long, pull off what you need, but keep the main bundle tied to the TowER's bike. Tie a bowline knot in the rope and clip it onto the carabiner. Then run the free rope back to the TowEE's bike.



3539
3540
3541
3542
3543

If you don't have passenger footpegs (shown below), attach the webbing to the rider's footpegs. Run the webbing up and over the saddle and place the carabiner in the middle. Attach the rope to the carabiner. Use a strap, duct tape, zip ties, or something else to keep the rope running down the middle of the TowER's bike. You don't want that tow strap to move sideways and foul the rear wheel.



3544
3545
3546
3547
3548
3549

Attach another piece of nylon webbing to the TowEE's bike's handlebars as shown in the lower left photo. Use a second carabiner in the middle of that webbing. If you have a windscreen you can possibly work around it as shown below at right. Alternatively you may need to remove the windscreen for the duration of tow.



3550
3551
3552
3553

3550

Whatever attachment points you use, think them through carefully. Don't get in a hurry, work methodically.



It will take some experimentation to determine the number of wraps you'll need to take around the carabiner. Too few and the rider can't hang on to the tail of the rope. Too many and the rope won't easily disengage.

Don't make your wraps around the "gate" of the carabiner

See Munter Hitch below for an alternative (superior) method



3554
3555
3556
3557
3558
3559
3560
3561
3562
3563
3564
3565
3566
3567
3568

The rider can hold onto the end of the rope with one hand, which keeps the towline attached. By releasing his hand the line easily detaches and the bikes are separated. To assist in separation, tap the brakes on the TowEE bike. Adapt your towing setup as needed, based on the gear you have, and the bikes involved.

Here's a superior method of attaching the tow rope to the carabiner – it's called the "Munter Hitch". Google it and you'll find it's commonly used as a descending device for mountaineering. This hitch is easy to control. Rope at bottom of photo runs to the towing unit. Rope at upper left runs to the towed rider's hand. Top end of carabiner is attached to the webbing that is hooked to the handlebars or upper fork tubes. If you let loose of the end of the rope, it quickly unwinds from the carabiner and the towed bike is released.

This rope runs to the TOWED rider's hand

Carabiner attaches to the webbing at the front of TOWED bike



Keep rope away from gate or latch on carabiner

This rope runs to the TOW bike

3569

3570

3571

3572 Towing can be dangerous. The strap can get caught in the wheels, causing both bikes to crash. Keep your speeds
3573 low, use EXTREME caution. If you're the TowEE and your buddy dragged you back home then you'll owe him
3574 dinner and a few beers for his efforts.

3575

3576 Here's a real-life story about towing a disabled bike using the Motorcycle Recovery System (MRS). Based on this
3577 episode (and lessons learned) I re-wrote the towing section and came up with improved techniques described in
3578 option 4 above :

3579

3580 In July 2012 I was on a GS ride with a dozen other motorcycles. We rode up to a mountaintop, took a short
3581 break, and then everyone fired up their bikes and headed back to the campsite - everyone except me. My
3582 BMW F800GS refused to start (fuel injection issue). We tried diagnosing the problem but had no success.
3583 Our only alternative was to tow my bike back to camp.

3584

3585 Using the MRS we hooked up a towline between Steve's bike and mine. We wrapped the rope around his
3586 right footpeg and he stepped on it to hold it in place, and we wrapped the rope around my left footpeg and I
3587 stepped on it to hold it in place. Off we went. We discovered that a 60-foot rope was too long for the
3588 twisting roads. At every turn the rope would cut across the apex of the turn and I would have to lift my left
3589 foot and release the rope. We didn't want to cut the rope, so we doubled it, which reduced the length to a
3590 more manageable 30 feet. This length put some space between the two bikes, and allowed us time to react
3591 to turns in the road and other obstacles.

3592

3593 One problem occurred whenever Steve made a right turn. As he turned right the towline would come in
3594 contact my shift lever and plunk the transmission from neutral into another gear, which immediately locked
3595 up the rear tire. Adapting, I removed the shift lever and the problem went away.

3596

3597 Because we were coming down the mountain, I had to make sure that on the downhill stretches I didn't start
3598 to gain momentum and close the gap between Steve's bike and mine. I had to ride my brakes to keep
3599 some tension in the rope. If I didn't then I ran the danger of riding over the top of the towrope, which
3600 would've caused major problems.

3601

3602 Twenty miles later Steve dragged my sorry butt back to the rally site. Of course I bought him dinner and a
3603 few refreshments for his efforts.

3604

3605

3606

Recovering a fallen bike.

3607

3608 Ever tried to bulldog a BMW R12GS that went over the embankment? I have. Even with lots of help the process is
3609 exhausting and may be, quite frankly, impossible. So what do you do? No tow truck in sight, no help nearby. You
3610 pull out the MRS (Motorcycle Recovery System) and you WINCH your bike back up where it belongs.

3611

3612 BestRest now has 2 versions of the MRS:

3613

3614 The Basic kit gives you a 3:1 mechanical advantage. A 150-lb rider can lift/pull a 450 pound bike. This kit is best
3615 suited for smaller bikes up to 500cc.

3616

3617 The Heavy Duty Kit gives you a 5:1 mechanical advantage. A 150-lb rider can lift/pull a 750 pound bike. This kit is
3618 best suited for larger bikes like the BMW F800GS/R1200GS, and the KTM 990/1190.

3619

3620 <http://www.bestrestproducts.com/p-340-motorcycle-recovery-system-mrs.aspx>

3621

3622



3623
3624
3625
3626
3627

Here's a photo of my friend Dr. Scott, pulling one of our KTM's up an impossible embankment where a bridge had washed out. I tried to ride up the slope but it kicked me off. Returning the way we came was not an option. In 3 minutes we had the MRS rigged up and the winching process began. It was surprisingly easy.



3628
3629
3630
3631
3632
3633
3634
3635
3636
3637
3638
3639
3640
3641
3642
3643
3644
3645
3646
3647

Jump Starting

Most big bore bikes use electric starters and don't even have a kick-starter for emergencies. You need to know how to get your bike started by some other means when it won't do it by itself.

1. You'll need jumper cables of some sort. These can be full sized cables like you use in your car, or they can be miniature cables designed for motorcycle applications (as long as there are alligator clips on both ends). You can even make jumper cables from sections of utility wire that you carry for emergencies, or wire that you find along the trail. The larger the gauge, the better. Keep the length as short as possible. BestRest has some compact cables for just this purpose: <http://www.bestrestproducts.com/p-357-jumper-cables.aspx>

One trick you can use when riding with a buddy is to remove the battery from his bike (fully charged), and take it over to your disabled bike. Leave your battery in your bike. Use a couple short pieces of wire to jump-start your bike, using his battery as the power source. Get your bike started and let it idle and charge, while you put his battery back where it belongs. This trick minimizes the need to carry a long jumper cables – all you need is about 18" of cable. Note: most bikes won't keep running when the battery is completely

- 3648 removed, so the idea of using his battery to start your bike, then hot-swapping batteries while your bike is
3649 idling, probably won't work.
3650
- 3651 2. Motorcycle electrical systems are fairly fragile, meaning that they won't tolerate large spikes in voltage or
3652 current. If you jump-start your bike you risk causing damage to your electrical system. Read your owner's
3653 manual, talk to your mechanic, and weigh the risks.
3654
 - 3655 3. Unlike the techniques used for jump-starting a car (leaving the engine running on the donor vehicle), I
3656 prefer to have the donor vehicle engine OFF when jump starting a motorcycle. This reduces the chances of
3657 a voltage or amperage spike. Motorcycles start fairly easily so having the donor engine running isn't
3658 necessary.
3659
 - 3660 4. Attach the cables so positive terminals are connected between both vehicles (your bike and the donor
3661 vehicle). Attach a negative lead to one vehicle's battery.
3662
 - 3663 5. Make the final connection to a negative grounding source away from the battery (attach to the frame). The
3664 last connection will result in a small spark. You don't want the spark anywhere near the battery (hydrogen
3665 gas may be present), or near the gas tank.
3666
 - 3667 6. Once connected wait a few moments, then hit your starter button. You'll know right away if the battery is
3668 hopelessly drained, or if it just needs a quick boost to turn over the motor. Don't run the starter for more
3669 than a few seconds or your jumper cables will overheat.
3670
 - 3671 7. If your bike has an accessory port that you use to draw power for an accessory, that port is NOT a suitable
3672 place to connect your jump-starter wires. The gauge (thickness) of wire running to that port probably won't
3673 handle the current and the wires may be damaged. Also, it's likely the port is connected into your bike's
3674 electrical system in some fashion. You want to avoid the bike's wiring system and get the electrons directly
3675 to the battery itself, completely bypassing the bike's electrical system.
3676
3677
3678
3679

3680 **Bump Starting**

3681
3682 If you can't get the bike started with the kick-starter or the electric starter, you can usually get it to run by bump
3683 starting. You'll need some muscle power or a downhill slope to help you pick up speed. You can also have your
3684 buddy tow you up to speed using his bike. See the section on towing. Here's how to bump start a bike:

- 3685 1. Ignition turned on and kill switch disengaged. Duh. I tell you this because more than once I tried to bump-
3686 start a bike, only to find that I didn't have the ignition turned on.
3687
3688
- 3689 2. If you're on flat level ground you'll need to push the bike and build up some speed. Clutch pulled in, tranny
3690 in 2nd gear. Sometimes it works best in 3rd gear depending on your tranny ratios. Push as fast as you can,
3691 run along side the bike.
3692
- 3693 3. When you've reached terminal velocity (you're going as fast as you can and your tongue is hanging out),
3694 quickly jump onto the saddle and put both feet on the pegs. Some riders jump on the bike sidesaddle. This
3695 position works, but it's a recipe for a tumble because it's easy to lose your balance, so I avoid it.
3696
- 3697 4. Keep your weight to the rear as though you're braking, then smoothly release the clutch. The rear wheel
3698 will begin to turn the engine over, hopefully getting it started. Don't pop the clutch or the rear wheel will
3699 lock. If it locks, pull in the clutch slightly.
3700
- 3701 5. Some riders find that jump-starting works more effectively if they suddenly drop their weight onto the saddle
3702 at the same moment they release the clutch. That body motion forces the rear wheel down into the ground,

- 3703 prevents the wheel from skidding, and forces the engine to turn over. Maybe this is where the term bump-
 3704 starting originated?
 3705
 3706 6. Repeat the above as needed. Pushing the bike up to speed takes quite a bit of energy, so rest in between
 3707 pushing episodes.
 3708
 3709 7. If you're on a hill you can dispense with running alongside and/or pushing the bike up to speed. Select 2nd
 3710 or 3rd gear.
 3711
 3712 8. Start downhill and let the momentum of the bike build up until you're going about 10 mph, then slowly
 3713 release the clutch. As the engine comes up to speed it should start running again.
 3714
 3715 9. The reason 1st gear is never selected when bump starting is that the ratio is too low. If you release the
 3716 clutch the engine won't turn over; all that will happen is that the rear wheel skids.
 3717
 3718

Exceptions to These Techniques

3719 Most of the techniques I've described work most of the time. There's always an exception to any technique. For
 3720 instance the technique I described for off camber riding has an exception when you encounter an obstacle. You
 3721 may need to push the bike away from the hill, putting your body on the uphill side, and allowing the bike to move
 3722 around the obstacle. Do what's necessary to keep the bike rolling, even if it breaks the rules. Just don't get in the
 3723 habit of using poor techniques all the time.
 3724
 3725

3726 Some riders may take exception to my techniques. Great! Write your ideas and we'll discuss them. I may even
 3727 add your ideas to the Article. Let's not argue – let's have a reasoned discussion.
 3728
 3729

3730 If you're wondering whether a certain technique would be appropriate for your particular riding situation, consider
 3731 purchasing the BestRest Common Sense Kit. You'd be surprised what problems you can solve when you have one
 3732 of these kits.
 3733

3734 Due to popular demand we now offer online Common Sense Certificates. You can download one here:

3735 <http://www.bestrestproducts.com/images/document/Certificate%20of%20Common%20Sense.pdf>
 3736
 3737



3738 Since we started manufacturing and selling the Common Sense Kit we've seen a real spike in sales. Unfortunately
 3739 most of those sales aren't going to riders who have actually have some common sense... instead they're going to
 3740 their buddies who lack common sense. Maybe the certificate will inspire them in some fashion.
 3741
 3742
 3743
 3744

Field Exercises – Practice Them

3745
3746
3747
3748
3749
3750
3751
3752
3753
3754
3755
3756
3757

Books and videos and personal instruction are great – they raise your cognitive understanding of Off Road Riding. But the rubber meets the road (or the knobby meets the dirt) when you take the time to practice on your own what you've learned from others.

I've listed some simple field exercises that you can practice anywhere, without the need to set up cones or layout a formal course.

Practice these drills with the bike UNLOADED. Only after you're comfortable with the way the bike handles and feels should you perform the drills with the bike fully loaded. A loaded bike handles much more slowly.

Five Riding Positions

3758
3759
3760
3761
3762
3763
3764
3765

Purpose: This drill shows you how to move around on the bike, adjusting your body position to match the riding terrain. It emphasizes forward-backward movements.

Put the bike on centerstand if it has one. Climb aboard.

Move thru the 5 riding positions:

3766
3767
3768
3769
3770
3771
3772
3773
3774
3775
3776
3777

1. **Sitting** – natural and comfortable
2. **Neutral** – standing comfortably up on the pegs in a neutral position
3. **Alert!** – standing, leaning slightly forward, knees gripping the tank
4. **Charge!** – standing, knees gripping the tank, your head and upper body aggressively forward over the bars
5. **Braking/Downhill** – standing, straighten your arms but don't lock the elbows, put your butt as far back on the bike as possible

Remember to move your feet on the pegs, as required to maintain control. Don't leave your feet in one position – put the instep on the peg, then the ball on the peg. Practice different foot movements.

Move from standing to sitting position and back again. As you do this, verbally describe to yourself what each position is intended to handle, and why it works. Say it out loud. People will think you're crazy - maybe you are. Consider the steps in this drill as your basic warm up exercise.

3784
3785
3786
3787
3788
3789

If your tankbag or duffel or other gear gets in the way of your movements you'll need to make adjustments. That means reorganizing your gear, or perhaps you need to get different gear. Don't compromise if your gear keeps you from being able to handle the bike.

Front and Rear Wheel Placement

3790
3791
3792
3793
3794
3795
3796
3797
3798
3799

Purpose: This drill helps you understand exactly where your front tire is in relation to an obstacle on the ground. Once you know where your tire is, you can figure out how to avoid rocks and other obstacles.

1. Pick a spot on the ground
2. Ride up to the spot (in a straight line) and place your front wheel exactly on top of that spot.
3. Keep practicing until you can consistently put the wheel on top of the spot.
4. Once you can do this, place two small stones on either side of the spot, wheel width apart.
5. Ride up to the spot and stop on it, without running over the stones.

- 3800 6. Once you can do this, ride in a circle (instead of a straight line), and place your front wheel on the spot
3801 7. As you ride away, turn the bars so your rear wheel misses the stones.
3802 8. Practice avoiding stones with both front and rear wheels, and also practice placing each wheel on a
3803 designated spot.
3804 9. Once you've mastered wheel placement and the rolling path of each wheel, you'll find that you can avoid
3805 many trail obstacles.
3806
3807

Braking – Rear Brake Only

3808
3809 Purpose: This drill shows you how to brake using only the rear wheel, and how to skid the rear wheel on loose
3810 surfaces.
3811

3812 Turn off ABS if your bike is equipped.
3813

- 3814
3815 1. Select a flat open area, free from obstructions. Smooth gravel is OK. An open field is OK but remember
3816 that grass is slippery. I like to practice this exercise on a quiet stretch of forest road.
3817
3818 2. Sitting on seat, accelerate slowly to about 5 mph, then apply the rear brake until the wheel locks up. The
3819 bike will slide to a stop. As the bike slides make steering corrections. Turn into the direction of the skid.
3820
3821 3. As you brake, move your butt back over the rear wheel, straighten your arms (elbows not locked).
3822
3823 4. Keep your feet on the pegs until you're nearly stopped, then put your left foot down to keep your balance as
3824 you come to a complete stop.
3825
3826 5. As you begin to feel comfortable with that skidding feeling, increase speed in small intervals, until you reach
3827 about 20 MPH.
3828
3829 6. If the bike doesn't skid straight and begins to slew sideways, and you release the rear brake, the bike will
3830 want to suddenly change direction and go the way it was headed at the moment you released the brake.
3831 (that means it'll shoot off in that direction) If you're not ready for that change you could lose control, so be
3832 careful. The good news about this sudden change is that this is the first step towards a more advanced
3833 technique, which involves skid-steering. See below.
3834
3835 7. If your beginning speed means you were in 2nd or 3rd gear before you began skidding, remember to shift
3836 down so you're in first gear by the time you come to a stop.
3837
3838 8. This technique isn't meant to imply that you should always lock up the rear when you apply the rear brake.
3839 Maximum braking is achieved while the wheel is still turning. Once the wheel is locked you sacrifice some
3840 measure of control, but at least you've thrown out the anchor and the bike will slow down.
3841
3842

Skid Steering

3843
3844 Purpose: This drill shows you how to use the skidding rear wheel as a tool for changing the direction of the bike.
3845
3846

3847 Turn off ABS if bike is equipped.
3848

- 3849 1. Refer to Para 6 in the section just above on Braking – Rear Brake Only
3850
3851 2. Begin your rear brake skid, and allow the bike to slew sideways (left or right) with the rear wheel locked.
3852
3853 3. Just before your rear brake is released, apply throttle and accelerate hard.
3854

- 3855
3856
3857
3858
3859
3860
3861
3862
3863
3864
3865
3866
3867
3868
3869
3870
3871
3872
3873
4. Be ready to dab the foot that's on the inside of the turn, if the bike begins to fall.
 5. At the moment the rear brake is released the bike will head in the general direction that the rear wheel was pointed. If the rear was skewed sideways at a 30 degree angle from your original line of travel, the bike will head off at about 1/2 that angle. This assumes you get your throttle timing just right – if you don't you might slide sideways and kiss the ground, or you might high-side.
 6. Skid steering is easier to do making left hand turns because your right foot is busy with the brake pedal.
 7. Skid steering looks really cool when you do it properly, but looks really stupid when you muff the technique and you fall down. Hopefully someone's got a camera rolling.
 8. This technique is best left for advanced riders, and for smaller bikes that are lightly loaded.
 9. At higher speeds if you let off the rear brake suddenly, the rear wheel may grab traction and you won't be ready for it. If that happens you'll do a spectacular and picturesque "high side". Use caution when practicing this technique.

Braking – Front and Rear

3874
3875
3876
3877
3878

Purpose: This drill teaches you how to apply both brakes on loose surfaces.

Turn off ABS if bike is equipped.

- 3879
3880
3881
3882
3883
3884
3885
3886
3887
3888
3889
3890
3891
3892
3893
3894
3895
3896
3897
3898
3899
3900
3901
3902
1. After you're comfortable with the feeling of the rear brake locking up, start using your front brake at the same time.
 2. Two fingers (only) on the brake lever, so you don't over-do it and lock up the front wheel. If you do lock it up, your chances of dropping the bike are very high.
 3. Gradually build up speeds. You'll find that proper application of both brakes results in a dramatically shorter braking distance. Just like on the street.
 4. Remember to move your butt rearward as you brake.
 5. The front of the bike will dive as you brake (suspension compresses). Butt moved back to compensate.
 6. If the front wheel hits an obstacle when the front brake is applied, the braking force will suddenly spike, which may cause the front wheel to lock up. If you see your front wheel is about to hit a rock or a rut, ease up slightly just before the obstacle, then reapply front brake.
 7. Just before you come to a complete stop, put your left foot down. You can alternate, and put the right foot down, but it's a bit harder to do.

Clutch and Front brake

3903
3904
3905
3906
3907
3908

Purpose: This drill teaches you where your clutch "slip point" is, and also teaches you how much front brake you can apply before the front wheel locks up. It also teaches you that you can keep the bike under control even when the front wheel is locked, as long as you keep the bike vertical. Once the bike goes off vertical, you'll fall down.

- 3909
3910
3911
3912
3913
3914
3915
3916
3917
3918
3919
3920
1. Sitting astride the bike, front brake applied.
 2. Apply throttle and slip clutch so the bike begins to move forward.
 3. Increase front brake until wheel locks.
 4. Increase throttle and release clutch enough so that forward motion continues.
 5. The front wheel will “plow” a furrow in the gravel.
 6. Use body language and turn the handlebars to maintain a straight line.

3921 I don't think you need to practice this technique every day, but you should do it occasionally so you get the feeling
3922 of the front wheel being locked up, and so you have confidence that you can still control the bike even when the
3923 front wheel stops turning.
3924
3925

3926 **Starting Out On A Hill**

3927
3928 **Purpose:** This drill teaches you how to start out when you're going UP a slope. Traction control is emphasized.
3929

3930 Select a slope that's manageable, ride partway up and stop.
3931

- 3932
3933
3934
3935
3936
3937
3938
3939
3940
3941
3942
3943
3944
3945
3946
1. 1st gear, front and rear brake applied, left foot on the ground.
 2. Apply throttle and slowly release the clutch. As you release, the engine will begin to bog down – more throttle will be needed to maintain rpm. You don't want to stall the engine, but you don't want to be revving the engine at redline either.
 3. As you begin to move uphill, push off with your left foot, and release the brakes.
 4. The rear wheel should barely spin, and the bike should begin moving up the hill.
 5. The rear wheel should not break loose, or spin madly, or throw up a rooster tail of dirt. If that happens you'll probably dig a trench and go nowhere.

3947 **Turning Around On A Hill**

3948
3949 **Purpose:** This drill teaches you how to stop as you're going up a hill, and how to turn around and go back down.
3950

3951 **Method 1 – U Turn**

3952 Select a slope that's manageable. Not too steep, not too gentle, just steep enough to provide a challenge.
3953
3954

- 3955
3956
3957
3958
3959
3960
3961
3962
3963
1. Ride partway up the hill.
 2. Just as you come to a stop midway up the hill, turn the bars to the right.
 3. Apply both front and rear brake to hold the bike in place.
 4. Put left foot down so you can hold the bike steady. (you can also practice putting right foot down, but it's more difficult because your foot must leave the rear brake)

- 3964
3965
3966
3967
3968
3969
3970
3971
3972
3973
3974
3975
3976
3977
3978
3979
3980
3981
3982
3983
3984
3985
5. You can remain in this position indefinitely, resting as needed. You can also lay the bike down on the left side and get off if needed. When you're ready you can remount.
 6. Turn handlebars to the left so the front wheel is pointing uphill.
 7. Release front brake and allow the front wheel to roll around (downward) in a large arc, so that the front of the bike is pointed slightly downhill. Keep rear brake locked and pivot on your left foot.
 8. With engine running, push away with your left foot and point the bike downhill, as you use your clutch to apply power, and ride down the hill. Easy peasy. Well, at least it will be after you've practiced a bit.
 9. If the hill is really steep, you may not want to roll the front wheel around in an arc. Instead, wiggle the bars back and forth. This motion will cause the front end to slide slowly downward. When the front wheel reaches a point where it's comfortable and you have control, push away with your left foot and apply power, release the rear brake, and ride down the hill.
 10. Reverse these techniques. Instead of turning to the right slightly just before you come to a stop on the hill, and instead of putting your left foot down, reverse these procedures. This time turn slightly to the left, and put your right foot down (on the upside of the hill) to steady the bike as you come to a stop. It's a harder technique because you can't keep your foot on the brake pedal, but in the real world you need to learn how to "switch hit" when conditions require.

Method 2 – Ride down backwards

3986
3987
3988
3989
3990
3991
3992
3993
3994
3995
3996
3997
3998
3999
4000
4001
4002
4003
4004
4005

Select a slope that's manageable. Not too steep, not too gentle, just steep enough to provide a challenge.

1. Ride partway up the hill.
 2. As you come to a stop midway up the hill, keep the bars pointed straight ahead.
 3. Let the engine stall, gently. Meaning let the engine die due to the grade of the hill
 4. Leave clutch lever out – which leaves the bike in gear
 5. The bike should be in 1st gear. If it isn't then tap the shift lever and get it into 1st
 6. Apply front brake and lock front wheel
 7. Apply rear brake
 8. Put left foot down to keep bike upright
 9. Stabilize the bike, making sure it doesn't start skittering backwards due to the slope. (If it does slide backwards, even with both wheels locked, lay the bike on it's side)
 10. Lean forward, place both feet on ground to act as stabilizers
 11. Slowly pull clutch lever and slowly release front brake lever
 12. As bike starts moving backwards, use clutch and front brake to retard rearward movement
 13. Dog-paddle your legs as you keep the bike upright, moving backwards down the slope
 14. When able, swing bars to right or left and allow the bike to roll perpendicular to the hill, then start the bike and ride down the hill
- 4006
4007
4008
4009
4010
4011
4012
4013
4014
4015
4016
4017
4018
4019

4020
4021
4022
4023
4024
4025
4026
4027
4028
4029
4030
4031
4032
4033
4034
4035
4036
4037
4038
4039
4040
4041
4042
4043
4044
4045
4046
4047
4048
4049
4050
4051
4052
4053
4054
4055
4056
4057
4058
4059
4060
4061
4062
4063
4064
4065
4066
4067
4068
4069
4070
4071
4072
4073
4074
4075

Figure 8's and Slalom Course

Purpose: These drills teach you how to quickly transition from a left hand turn to a right hand turn, how to make increasingly tight turns, and how to avoid obstacles along your path.

Running a Figure 8 or Slalom Course is an excellent method to improve turning skills and to practice body positioning. You can get fancy and set up some cones, but I generally use things like clumps of bushes, sticks, or cow pies.

Remember that you're concentrating on PROPER TECHNIQUE, not on speed. You'll be moving the bike back-and-forth, pushing the bars down toward the cones.

Some riding schools teach you to lift your inside foot (take it off the footpeg) as you make a tight turn. Their thinking is that when lift the inside foot you reduce the chance of falling on your foot and causing injury, AND by pointed the lifted foot toward the inside of the turn, it will be instantly available to dab the ground and make a balance correction. OK, I can buy that argument. There's more than one way to skin a cat. We must be open to different techniques and styles.

However, developing a habit of removing your feet from the pegs as you make a turn goes contrary to most OR riding techniques. Think of it this way - riding with one hand off the handlebars compromises your control. Riding with one foot off the pegs does the same thing.

For that reason I keep my feet on the pegs under almost all riding conditions, EXCEPT when making a hairpin powered turn like you'd encounter on a trail switchback.

Figure 8's.

Set up the "cones" about 3 bike lengths apart. Stand on the pegs. Slowly ride around the cones and between them in a figure 8 pattern.

1. Your speed should be above an idle, somewhere around a fast walking speed. Use your throttle and clutch to control your speed. Also use the rear brake if needed. You can ride the brake to keep your speed down.
2. As you make a turn around the cone, press down on the toe closest to the cone.
3. On the other leg, turn your knee inward toward the gas tank and push the tank toward the cone.
4. Take the handlebars and laterally push them sideways as though you're going to touch the cone with the end of the handlebar.
5. Move your body to the outside of the bike, placing yourself further away from the cone.
6. The bike will make a turn around the cone, then you'll bring the bike upright and reverse these steps so you can make an opposite turn around the 2nd cone.
7. Repeat the cone drill until you feel comfortable.
8. Move the cones closer and closer together, until there's barely enough room for you to make the turns.
9. The closer together they are, the slower you'll need to go. Eventually you can do this full lock to full lock.

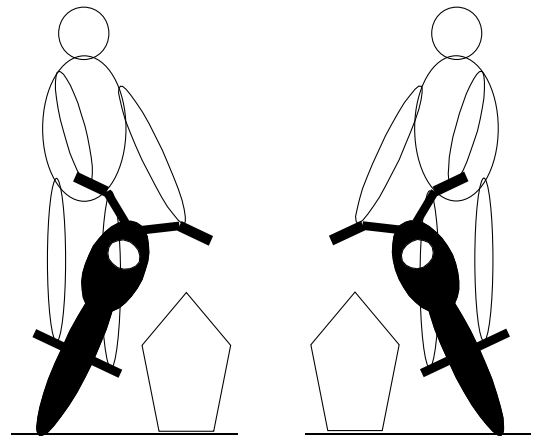

4076
4077
4078
4079

10. If you stall the engine during this drill, the bike will fall inward toward the cone. No worries, you were going slowly and the distance to the ground was only a few inches. Pick the bike up, correct the error that led to the fall, and keep practicing. At right I fell down because I stalled the engine.



4080
4081
4082
4083
4084
4085

Keep practicing, making the turns tighter and tighter, moving the cones (jackets) in closer and closer.

Don't just do this drill on smooth surfaces.... throw in some uneven terrain or some ruts to make things interesting.



4086
4087
4088
4089
4090
4091
4092
4093
4094
4095

Slalom Course

The slalom course should have about 6 or 8 cones or cow pies. If they're fresh that adds to the excitement of the drill. There should be some height to the cone so that you learn how to judge vertical clearance of an obstacle. If you're using cow pies you'll need to stack them pretty high, or you could use the old "cow-pie-on-a-stick" technique. Fresh pies don't work very well on a stick, in case you're wondering. The cones don't need to be staggered evenly; in fact they should be uneven so you're forced to make adjustments. Don't make things too easy.

4096
4097
4098
4099
4100
4101
4102
4103
4104
4105
4106
4107
4108
4109
4110
4111

1. As you approach the cones, swing just wide enough to clear the cone with your wheels, feet, and panniers. You'll be learning how much room you'll need to clear the cone. If you knock one over then you're cutting the corner too close. When you're on the trail that cone will come in the shape of a big rock or a tree stump.
2. Control your speed using throttle, clutch, and brakes.
3. As you weave between the cones your body will be moving from side-to-side. You'll be pressing down with your toes on the inside of the turn, turning your knee into the tank on the outside of the turn, moving your handlebars laterally, and using body English to control the bike as it clears each cone.
4. Your speed should start out slow, and gradually increase as you develop proficiency.
5. You're looking for proper technique and smooth application of clutch and throttle. Don't try to go thru the slalom as fast as you can, unless you're trying to impress someone other than yourself.



4112
4113
4114
4115
4116
4117

I'm pressing down with my toes closest to the inside of the turn, I'm pressing my knee into the tank from the outside of the turn, I'm moving my bars laterally in toward the turn. I'm looking at the path I intend to take between the obstacles – I'm NOT looking at the cones themselves.



4118
4119
4120

4121
4122
4123
4124
4125
4126
4127
4128
4129
4130
4131
4132
4133
4134
4135
4136
4137
4138
4139
4140
4141
4142
4143
4144
4145
4146
4147
4148
4149
4150
4151
4152
4153
4154
4155
4156
4157

Static Balance Drills

Purpose: This drill will teach you how a small movement by your body will have a big impact on the balance of the motorcycle. It will also show you that if you're tensed up as you ride, your body will transmit that "energy" down into the motorcycle, and that will affect your balance.

Off Road riding is all about balance and body movement. If you move your leg a certain way, the bike responds. If you lift your arm slightly, the bike responds. Even if you hold your breath instead of breathing normally, the bike responds. These drills reinforce the importance of body balance, and give the rider confidence when it comes to balancing or holding up the bike. They're best practiced when there's no wind blowing, and when nobody's around to watch you (that's because you look kinda silly as you're doing them).

Drill 1. Body Balance

1. Find a smooth dirt surface. Sit astride the bike. Look straight ahead. Breathe slowly and normally. Turn the handlebars full lock left and right several times, so the front wheel digs down into the dirt an inch or two and builds up a small berm. Then turn the handlebars full to the left or right, and leave them there with your hands on the grips.
2. Apply full rear brake and leave your foot on the right footpeg.
3. Balance the bike using only your left foot. Slowly, gently, gradually find the balance point of bike and rider, and try to lift your left foot and place it on the footpeg. Yes, I'm telling you to lift the only foot that you've been using for support!
4. At first this drill seems impossible, but if you really concentrate on your balance point, your breathing, and relaxing your body, in about 15 minutes you'll have that left foot up on the peg, even if only for a few seconds.
5. Once you have both feet up on the pegs, you'll notice that it only takes a tiny movement of an arm or a leg, or a heavy breath, or tension in your shoulders, and you'll have to put a foot down to catch your balance. What you're discovering from this drill is just how little movement it takes on your part to make the bike stable, or unstable. When the bike's unstable, it changes directions. You want to be control stability according to your own terms.



4158
4159
4160

The bike weighs over 600 pounds. That's 3 times my weight. Keeping her balanced is all about subtle technique.

4161
4162
4163
4164
4165
4166
4167
4168
4169
4170
4171
4172
4173
4174
4175
4176
4177
4178
4179
4180
4181
4182
4183
4184
4185
4186
4187
4188
4189
4190
4191
4192
4193
4194
4195
4196
4197
4198
4199
4200
4201
4202
4203
4204
4205
4206
4207
4208
4209
4210
4211
4212
4213
4214
4215
4216

6. If you practice this drill long enough, you'll eventually be able to stand on the pegs. And if you really practice a lot, you'll be able to stand on the pegs and lift your arms like I'm doing in the right photo.
7. As stupid as this might look, it's a drill that really improved my OR riding abilities. Because I'm not a big guy, I have to rely on technique and subtle balance. This drill helped me develop those skills.

Drill 2. Keep the Bike Balanced Using One Finger

1. It's a good idea to have a friend help you with this drill. They should stand on the opposite side of the bike, acting as a "safety" in case the bike falls away from you.
2. Stand beside the bike. Hold the bike with 1 hand. Gradually relax your hand, so that you're not holding the bike with a firm grip. Ease your hand back so that the only thing touching the bike is a single index finger.
3. You'll find that you can keep your 600-pound motorcycle remain upright, using only 1 finger! How cool is that?
4. Now start slowly moving around the bike, using first one index finger, then the next, keeping the bike upright. Your goal is to do a complete circumnavigation of the motorcycle, keeping it balanced using only 1 finger at a time.
5. This drill teaches you the exact balance point of the motorcycle, and gives you confidence in knowing that even the smallest input can have dramatic results.

Off Camber

Purpose: This drill will prepare you for crossing slopes at an angle (not just going straight up or down).

Select a road or trail that traverses a slope. That means it doesn't go up or down, but goes sideways across the slope. The surface of the road or trail should not be level.

1. Ride slowly across the road or trail, standing on the pegs in a Standing **Alert!** position.
2. Take the handlebars and push them laterally in toward the hill. Imagine that you're going to scrape the hill with the end of your handbar. Place your body on the outside of the bike, as though you were climbing on top of a bike that's lying flat on the ground. These exaggerated descriptions help you remember the proper positioning of both bike and rider.

The guy on the Left is doing it **WRONG**.

The guy on the Right is doing it **RIGHT**.

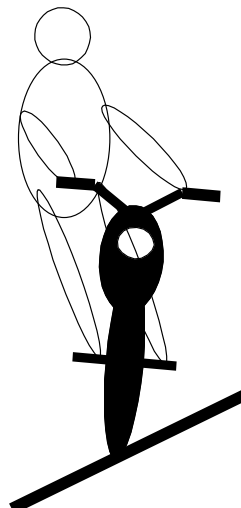
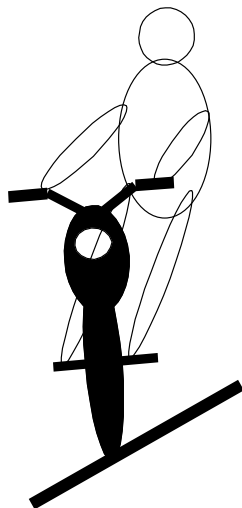

- 4217
4218
4219
4220
4221
4222
4223
4224
4225
4226
4227
3. As you ride across that off-camber surface, the bike will be “driven” into the earth by your body weight. The sides of the tires will be touching the ground, not the center of the tread.
 4. If you lose control, such as losing traction, or lose your balance or stall the engine the bike will come to rest on the ground. You’ll be on top of the bike, instead of under it.
 5. If you do this drill in error, and put your body between the hill and the bike, and you lose traction, one of two things will happen: 1.) The bike will fall onto you, pinning you to the ground, or 2.) The bike will fall away from you, heading downhill, and you’ll be helpless to correct or recover the error.

Sand and Mud

4228
4229
4230
4231
4232

Purpose: This drill will prepare you for crossing soft sections of terrain. It will test your ability to keep your weight back on the bike, allowing the front end to be lighter, preventing the front end from plowing.

4233
4234
4235
4236
4237

Most riders aren’t very keen on the idea of searching out a stretch of sand or mud, just so they can practice their sand/mud techniques. I’m among their ranks. But the truth of the matter is that if you never practice a technique, you’ll never have a chance to develop the skills you’ll need when you encounter them in the field. It’s not a lot of fun, but you’ve got to do it anyway.

4238
4239
4240
4241

Find a short stretch of sand and/or mud that has good approach and exit points, both made from firmer ground. The sand/mud stretch should be long enough that you’ll be able to get the feel of the bike when it’s traveling over those surfaces, but not so long that you’ll get out of control or lose your self-confidence.

4242
4243
4244
4245

Approach the sand/mud trap at about 5 mph. Before you enter the trap, stand up and move your butt over the rear wheel, straighten your arms, but don’t lock your elbows. The front of the bike will be fairly light due to your weight transfer, which allows the front wheel to skim over the sand/mud surface to some extent.

4246
4247
4248

As you enter the sand/mud accelerate slightly. This will further lighten the front end, and it will also serve to drive the bike thru the trap.

4249
4250
4251
4252

As you exit the trap your speed should be equal to or slightly higher than it was when you entered the trap. If you slow down in the middle of trap your front wheel will begin to “plow”. There’s a good chance you’ll fall, especially if you suddenly chop the throttle closed.

4253
4254
4255

As you build confidence going thru the sand/mud trap, increase your speed slowly. Run the gauntlet several times and find your own comfort zone, determining your limits and finding the speed that works best for you.

4256
4257
4258
4259
4260
4261

In the next photo you can see that Steve’s crossed the obstacle and he’s on solid ground. During his crossing he left a few dark patches, which show where he hit a soft spot and dabbed a foot to keep his balance. In order to consider this a “practice drill”, Steve will have to turn around and repeat the creek crossing several times, practicing the techniques until he’s comfortable. On this ride it wasn’t long before Steve had mastered both sand and mud.



4262
4263
4264

Swing-A-Leg Drill

4265
4266
4267
4268
4269

Purpose: This drill teaches you that you can move around the bike quite a bit, and still keep your balance. It also shows you how the bike responds to body movement. As a final benefit you can use this drill to relieve muscle tension when you're on a long ride.

4270
4271

On a clear stretch of forest road, at a reasonably low speed, stand on the pegs. Lean slightly forward.

4272
4273
4274

Take your left foot and lift it off the peg. See how the bike responds and then you compensate as needed so you maintain a straight course.

4275
4276

Do the same drill using your right foot. Compensate your steering.

4277
4278

Once you feel comfortable with only 1 foot on the pegs, lift that raised foot, bend your leg at the knee, then put your knee on the seat. Compensate your steering.

4279
4280

After that drill feels comfortable, swing that leg entirely across the back of the saddle so that both legs are on one side of the motorcycle. Your master foot remains on the peg. The angle of bike angle (to the ground) will be as much as 30 degrees off center.

4281
4282
4283

Switch legs, moving back and forth. Get used to moving your legs around the bike, learning how the bike handles, and learning how to compensate for your movements.

4284
4285
4286

Once comfortable with that drill, try sitting down side-saddle, with both feet on one side of the bike. This drill is a admittedly a bit dangerous because the tendency is to fall over toward the side where there's no legs. So why do it, you ask? Only do it if you're really comfortable, really proficient, and really bored on the ride. If you fall down and break your head don't blame me.

4287
4288
4289

These swing-a-leg drills don't apply directly to any specific OR situation that you would typically encounter in the field. It's unlikely that you'll need to ride sidesaddle up a long hill, but you'll certainly impress your buddies if you ride into camp that way. You might receive a few comments that aren't fit to print....

4290
4291
4292
4293
4294
4295
4296

4297 These drills do give you an understanding of body balance, compensation techniques, and they also give you
4298 something to do when you're bored out of your mind on a long stretch of gravel or pavement. I wouldn't
4299 recommend them in sand, mud, or other conditions. And they're probably not legal on the highway, so don't tempt
4300 the local constabulary and ride thru town that way.
4301
4302

4303 Conclusion

4304
4305 I hope this Article accomplished my goal – to educate and inform. If only 1 rider gains something from reading all
4306 100 + pages, I'll consider my efforts successful. That'll put a smile on my face, like the one you below. You're
4307 looking at a medical condition known as "Happy Goggle Face", which I contracted after riding the single track trails
4308 near Mt. St. Helens. My riding buddy Dr. Scott Reichard says the condition is highly contagious and unfortunately
4309 its incurable, but it can be kept under control with regular doses of off road riding. He actually wrote a prescription
4310 which I show to my Lovely Wife whenever I need to get out and ride.
4311



4312
4313 Remember – this is not an Article for expert OR riders. It's for BEGINNERS, for guys and gals that want learn more
4314 about OR'ing, those who are new to the sport, or those who might know a little bit but want to expand their
4315 knowledge. If you want to get your Off Road Riding Diploma then you need get some professional training. You
4316 certainly won't earn your Master's Degree from just reading this Article, but it's a good place to start.
4317
4318

4319 I'll be adding to the Article as time permits. I wrote it rather quickly (the first draft only took me a couple weekends)
4320 and there's still a lot of work to do, such as improving descriptions of the techniques, fixing grammatical errors,
4321 adding photos, etc. Check the website for updates. <http://www.bestrestproducts.com/>
4322

4323
4324
4325
4326

You can also call to discuss this Article, although my time may be limited due to the demands of work. The best way to contact me is via email. info@bestrestproducts.com



4327
4328

Above photo was taken on the Continental Divide Ride, somewhere in New Mexico. I fell over because I was going too slow and because I was turning my head to watch Steve's progress behind me. I was actually looking back over my shoulder. Dumb stunt #1 of 100. During that 2800-mile journey I fell once, Steve fell twice. No harm, no real damage. We had lots of fun in spite of our tumbles, and we had many laughs along the way. That's what Off Road Riding is all about.

4334
4335

If you want to see photos of that ride (and others), go here:

4336
4337

http://bestrest.smugmug.com/gallery/5409113_CPUta#!i=343443125&k=bHyhW

4338
4339

http://sirby.smugmug.com/gallery/5380554_nr6Xk#329561608

4340
4341

If you find me on some lonely road maybe we can sit around the campfire and talk about riding. Or if you find my bike laying on its side you can help me get it back up on 2 wheels. Maybe you'll just stand there and watch me do it, to make sure I use the proper lifting techniques. Practice what you preach, and all that. 8^)

4342
4343

If you write or call, remember to mention the date of the Article, as well as the line number and the topic of discussion.

4344
4345

See you on the trail. May the Lord God keep you safe on your 2-wheeled journeys.

4346
4347

David Petersen, Mr. BestRest

4348
4349
4350

4351
4352
4353
4354

As a parting photo, I thought you'd like to see a friend I met during one of my travels. That's a Western Diamondback Rattlesnake. He liked my GS, crawling all over it exploring nooks and crannies. He didn't like me.



4355